

Operating Instructions

LCD Projector

Model No. **PT-L5**

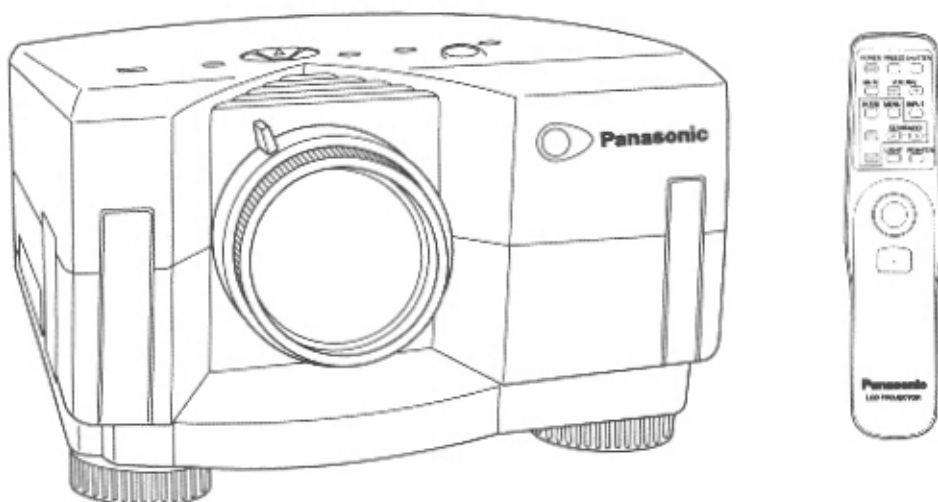

Panasonic®

Please read these instructions completely before operating this LCD Projector.

Things You Should Know

Caution: This equipment has been tested and found to comply with the limits for a Class B digital device, pursuant to Part 15 of the FCC Rules. These limits are designed to provide reasonable protection against harmful interference in a residential installation. This equipment generates, uses, and can radiate radio frequency energy and, if not installed and used in accordance with the instructions, may cause harmful interference to radio communications. However, there is no guarantee that interference will not occur in a particular installation. If this equipment does cause harmful interference to radio or television reception, which can be determined by turning the equipment off and on, the user is encouraged to try to correct the interference by one or more of the following measures:

- Reorient or relocate the receiving antenna.
- Increase the separation between the equipment and receiver.
- Connect the equipment into an outlet on a circuit different from that to which the receiver is connected.
- Consult the dealer or an experienced radio/TV technician for help.

Declaration of Conformity

Model Number: PT-L5
Trade Name: **Panasonic**
Responsible party: Matsushita Electric Corporation of America.
Address: One Panasonic Way Secaucus New Jersey 07094
Telephone number: 1-800-528-8601

This device complies with Part 15 of the FCC Rules, Operation is subject to the following two conditions:
(1) This device may not cause harmful interference, and (2) this device must accept any interference received, including interference that may cause undesired operation.

FCC Caution: To assure continued compliance and prevent undesirable interference, use only the provided shielded VGA cable with 2 ferrite cores while connecting LCD to computer and all other connecting cables should be shielded. Any changes or modifications not expressly approved by the party responsible for compliance could void the user's authority to operate this equipment.

Congratulations

on your purchase of one of the most sophisticated and reliable products on the market today. Used properly, we're sure it will bring you and your family years of service enjoyment. Please take time to fill in the information below. The serial number is on the tag located on the back of your LCD Projector. You'll want to keep this manual handy as your convenient LCD Projector information source. For your own protection and prolonged operation of your LCD Projector, please be sure to read the "Important Safeguards" carefully, before use.

Date of Purchase _____

Dealer Purchased From _____

Dealer Address _____

Dealer Phone No. _____

Model No. **PT-L5** _____

Serial No. _____

Table of Contents

Things You Should Know	2	Basic LCD Projector Operation	19
Important Safeguards	3	Using other useful functions	20
LCD Projector Features	5	Projected Image Adjustment	22
Contents of LCD Projector Box	6	ProMouse Control Feature	25
Product Information	7	Status Code Display Indications	30
Turning the power on and off	9	Cleaning the Air Filter	31
Positioning the LCD Projector and Screen	10	Lamp Replacement	32
LCD Projector Initial Setup	11	Before Requesting Service	34
Connecting the LCD Projector	12	Specifications	35
Video/ Computer Cables & Adaptors	13	Notes importantes concernant la sécurité	36
Pin Assignment	14	Remplacement de la lampe	38
Factory Preset Timing	16		

© 1998 Matsushita Electric Industrial Co., Ltd

All product/brand names are trademarks or registered trademarks of the respective holders.

Important Safeguards



CAUTION: Please read all of these instructions before you operate your LCD Projector. Save these instructions for future reference.

Electrical energy can perform many useful functions. This LCD Projector has been engineered and manufactured to meet applicable safety standards. But IMPROPER USE CAN RESULT IN POTENTIAL ELECTRICAL SHOCK OR FIRE HAZARDS. In order not to defeat the safeguards incorporated into this LCD Projector, observe the following basic rules for its installation, use and servicing.

- 1 Unplug the LCD Projector from the wall outlet before cleaning.
- 2 Do not use liquid cleaners or aerosol cleaners. Use a soft dry cloth to clean the LCD Projector unit. If the unit is very dirty, wet a cloth with neutral detergent, squeeze it tight, wipe the unit with it, and finish by wiping with a dry cloth. Do not use a chemical duster or polisher-cleaner because it can adversely affect the unit and peel the paint coat.
- 3 Do not use attachments not recommended by Panasonic, as they may cause hazards.
- 4 Do not use the LCD Projector near water; for example, near a bathtub, washbowl, kitchen sink, laundry tub, in a wet basement, near a swimming pool, etc. Never spill liquid into the LCD Projector.
- 5 Do not place the LCD Projector on an unstable cart, stand, or table. The LCD Projector may fall, which may cause serious injury to a child or an adult, and/or serious damage to the unit. Use only with a cart or stand recommended by its manufacturer, as being suitable for use with an LCD Projector.
- 6 Ceiling, wall or shelf mounting for installation should use a mounting kit approved by the manufacturer for use with an LCD Projector and should follow the manufacturer's instructions.
- 7 LCD Projector equipment and cart combinations should be moved with care. Quick stops, excessive force, and uneven surfaces may cause the equipment and cart combination to overturn.
- 8 Slots and openings in the cabinet back and bottom are provided for ventilation. To ensure reliable operation of the LCD Projector and to protect it from overheating, these openings must not be blocked or covered. These openings should never be covered with cloth or other material. The bottom opening should not be blocked by placing the LCD Projector on a bed, sofa, rug, or other similar surface. The LCD Projector should not be placed near or over a radiator or heating vent. The LCD Projector should not be placed in a built-in installation such as a bookcase unless proper ventilation is provided.
- 9 The LCD Projector should be operated only from the type of power source indicated on the back of the LCD Projector or in the specifications. If you are not sure of the type of power supplied to your home, consult your LCD Projector dealer or local power company.
- 10 Do not allow anything to rest on the power cord. Do not place the LCD Projector where the cord will be walked on.
- 11 Follow all warnings and instructions marked on the LCD Projector.
- 12 As a safety feature, this LCD Projector is equipped with a 3-prong grounded plug. The 3-prong grounded plug will fit only into a grounding type power outlet. If the plug does not fit, use an adaptor that is properly grounded or have an electrician install a grounded type outlet. Do not attempt to modify this AC plug.
- 13 For added protection of the LCD Projector during a lightning storm, or when it is left unattended or not in use for long periods of time, unplug it from the wall outlet and disconnect any cable systems. This will prevent damage to the projector due to lightning and power-line surges.
- 14 Do not overload wall outlets and extension cords with too many products, because this can result in fire or electric shock.



- 15** Never push objects of any kind into the LCD Projector through cabinet slots as they may touch dangerous voltage points or short out parts, which could result in a fire or electric shock.
- 16** Do not attempt to service the LCD Projector yourself. Opening or removing covers may expose you to dangerous voltage or other hazards. Refer all servicing to qualified service personnel.
- 17** Unplug the LCD Projector equipment from the wall outlet and refer servicing to qualified service personnel under the following conditions:
 - A. When the power cord or plug is damaged or frayed.
 - B. If liquid has been spilled into the LCD Projector.
 - C. If the LCD Projector has been exposed to rain or water.
 - D. If the LCD Projector does not operate normally when you follow the operating instructions. Adjust only those controls that are covered by the operating instructions; improper adjustment of other controls may cause damage and will often require extensive work by a qualified technician to restore the LCD Projector to normal operation.
 - E. If the LCD Projector has been dropped or the cabinet has been damaged.
 - F. When the LCD Projector exhibits a distinct change in performance – this indicates a need for service.
- 18** Upon completion of any service or repairs to the LCD Projector, ask the service technician to perform a routine safety check to determine that the LCD Projector is in safe operating condition.
- 19** When replacement parts are required, be sure the service technician has used replacement parts specified by the manufacturer that have the same characteristics as the original parts. Unauthorized substitutions may result in fire, electric shock, or other hazards.
- 20** Air filter should be cleaned every 100 lamp on hours.
LCD Projector may become too hot if filter is not cleaned when required.
- 21** If lens becomes dirty, or smudged, clean with a clean, dampened cloth. Never touch the lens with your fingers.
- 22** Do not look directly into the aperture and lens while operating as this may result in damage to your eyes.

LCD Projector Features

1 High Brightness and Resolution

1,440,000 (3 X 800 X 600) pixel format, 450-lumen (ANSI) offers clear images even when ambient light level is high.

2 Compact and Lightweight

Completely portable, you can give attractive presentations at any location by connecting the PT-L5 to a computer or video equipment.

3 20 to 300 Inch Screen Capability

Project a screen size of 20" to 300" from a distance of 3.18 feet to 51.84 feet. (See table on page 10.)

4 Compatible with Most Personal Computers

The RGB input accepts signals from VGA, SVGA, XGA (Compression), and MAC compatible computers with no additional hardware. Other compatible computers require a separate cable.

5 Accommodates 6 different video signal standards

This LCD Projector accepts the input signal of all major video formats, including PAL, SECAM, NTSC, PAL-M, PAL-N, NTSC4.43, and the higher quality S-Video signals.

6 On Screen Display

This LCD Projector's language is set to English at the factory. In addition, you can select, Spanish, French, German and Italian. Information screens and menus make setting up and operating the LCD Projector extremely easy.

7 IR Remote Control

Front and rear sensors allow you to control the projector from almost anywhere in the room.

8 Stereo Audio Output

For external audio equipment connection. Audio follows video source.

9 ProMouse Control Feature

This feature allows you to use the LCD Projector remote control as a mouse to control your personal computer. There is also an Auto Setup feature which identifies the signal mode and automatically adjusts the Vertical position, Horizontal position, Horizontal size and Phase. (See page 25.)

10 Automatic Universal Power Supply with Automatic Power Down

This unit has an operating voltage range of AC 100 - 240V. The lamp power is automatically turned off if there is no Input Signal for 15 minutes.

Equipped with a variety of convenient functions

A variety of functions such as the following have been provided.

- A blue screen is projected when no signal is being input.
- Mute or freeze functions for video and audio signals can be toggled on and off.
- The input signal display function can be toggled on and off.
- Cancellation of the enlarging function is provided.
- 16:9 (wide) screen projection is provided.
- The function of the POWER Button on the remote control can be disabled.
- Rear screen projection is provided.

Contents of LCD Projector Box

Please confirm that the following items are packed in the LCD Projector box. They are provided to help you use or set up your LCD Projector.

- (1) LCD Projector
- (2) Remote Control (LRQ90017)
- (3) 2 "AA" Batteries
- (4) 9.8 Foot UL/CSA Power Cord (VJAS0179)
- (5) VGA Cable (LSJA0133)
- (6) VGA MAC Adaptor (LSJA0158)
- (7) Audio/Video Cable (Audio:LSJA0076/Video:LSJA0074)
- (8) RS-232C Cable (LSJA0077)
- (9) RS-232C 9-pin Adaptor (LSJA0078)
- (10) RS-232C 25-pin Adaptor (LSJA0079)
- (11) 3.5 inch Floppy Disk of Pro-Mouse for Windows 95 (LSFT0159)
- (12) 3.5 inch Floppy Disk of Pro-Mouse for Macintosh (LSFT0160)
- (13) Operating Instructions (Please read completely before operating.)
- (14) Warranty Card
- (15) Service Center List

Product Information

Remote Control

[Front]

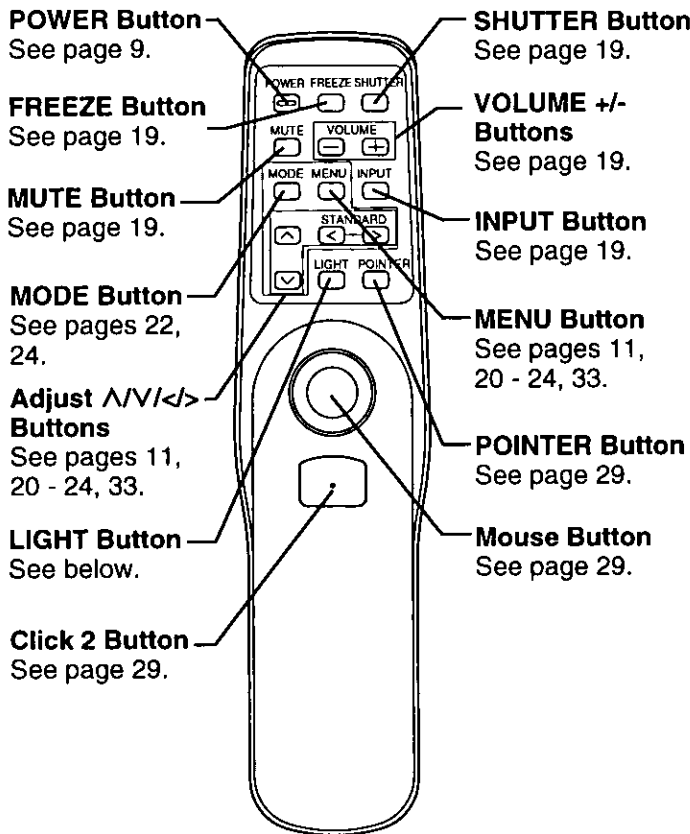

[Side]

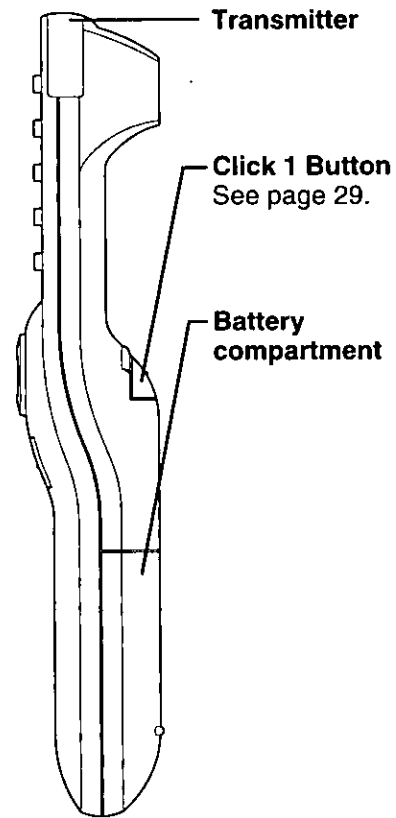

■ Before using the Remote Control

• Load the 2 "AA" batteries in the Remote Control

1 Slide the lid in the direction of the arrow.

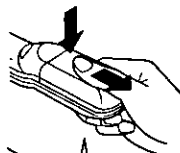

2 Install 2 "AA" batteries as indicated inside the Battery Compartment.

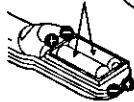

3 Replace the lid and snap into place.

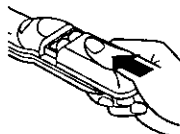

Battery replacement caution

- Do not mix old and new batteries.
(Also never mix alkaline with manganese batteries.)

Note:

- Do not place the remote control unit upside down, otherwise the Mouse button may be pressed down, which cause the batteries to be consumed.

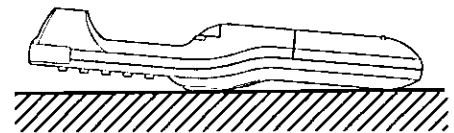

• Remote Control Operating Range

When using the remote control, point it at the front or rear of the LCD Projector or at the projection screen. The range for optimum operation is within 30 degrees of the receiver at a maximum distance of about 23 feet (7m).

• Remote Control Light Up

Press the LIGHT Button to illuminate the function buttons on the remote control for 10 seconds. The light goes out while any button is pressed down, and then comes back on for an additional 10 seconds when the button is released.

LCD Projector

[Top and Front]

MODE Button
See pages 22, 24.

MENU Button
See pages 11, 20 - 24, 33.

INPUT Button
See page 19.

VOLUME +/- Buttons
See page 19.

STATUS CODE
See page 30.

Adjust $\Delta/V/\triangleleft/\triangleright$ Buttons
See pages 11, 20 - 24, 33.

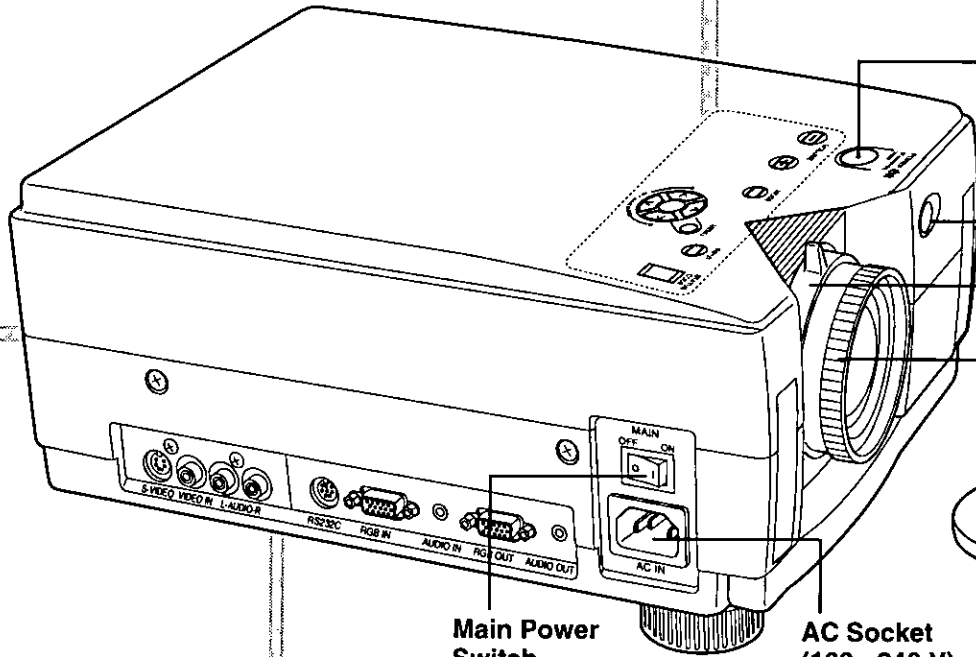

POWER Button/STANDBY(R) ON(G) Indicator
See page 9.

Remote Control Sensor

Zoom Ring
See page 11.

FOCUS Ring
See page 11.

Main Power Switch
See page 9.

AC Socket (100 - 240 V)
See page 9.

Lens Cap

[Side]

S-Video Input Connector
See page 13.

RS232C Connector
See page 12.

Audio Input Connector
See page 12.

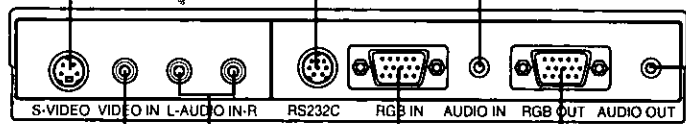

Audio Output Connector
See pages 12 - 13.

Video Input Connector
See page 13.

Audio Input Connector (L/R)
See page 13.

RGB Input Connector
See page 12.

RGB Output Connector
See page 12.

[Back]

Air outlet port

Remote Control Sensor

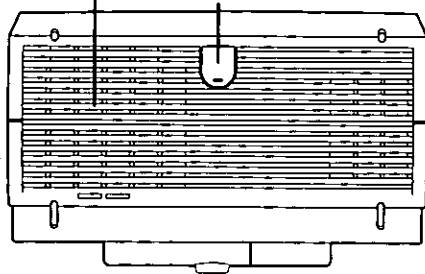

[Bottom]

Carrying handle

Adjusters
See page 11.

Lens Cap Holder

Air Filter
See page 31.

Lamp Cover Screw
See page 33.

Lamp Cover
See page 33.

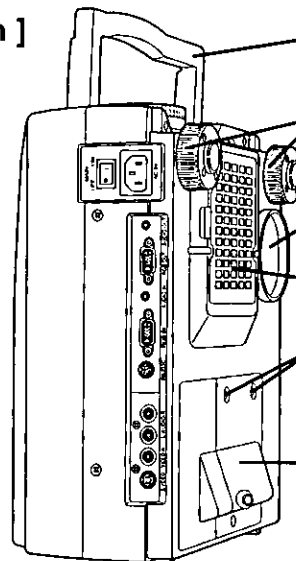

Turning the power on and off

If the MAIN Power switch on the LCD Projector is pressed while the cooling fan is still operating, the operating life of the projector lamp will be shortened. Be sure to follow the procedures given below when turning the LCD Projector power supply on and off.

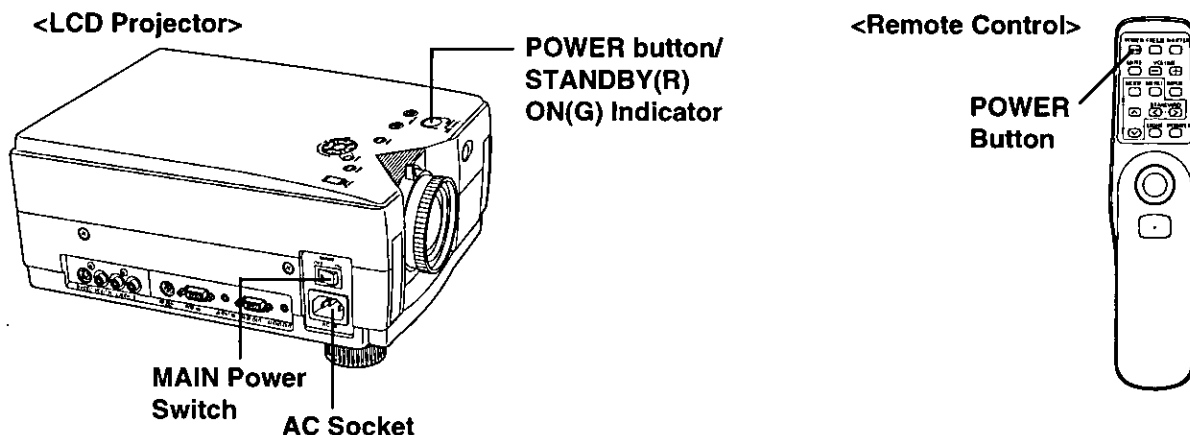

Turning on the power

- 1** Insert Power Cord into LCD Projector AC socket and connect to properly grounded wall outlet.
- 2** Set the MAIN Power Switch on the LCD Projector to ON.
The STANDBY(R) ON(G) indicator lights red.
 - The first time you turn on the power, or whenever the STANDBY(R) ON(G) indicator is not lit, press the Main Power Switch (ON/OFF) to turn on the power.
- 3** Press POWER button on the LCD Projector or remote control.
The STANDBY(R) ON(G) indicator flashes green while the LCD Projector is warming up, and then changes to solid green when the picture is projected on the screen after approximately 45 seconds.

When the power is on, the STANDBY(R) ON(G) indicator indicates the operating condition of the lamp.

Red:	Main Power On (Lamp Off)
Green:	Lamp is ready
Flashing green:	Warming up
Flashing red:	Cooling Fan operating

Turning off the power

- 1** Press POWER button on the LCD Projector or remote control.
The STANDBY(R) ON(G) indicator flashes red while the LCD Projector cools down, and then changes to solid red when fan stops after about 1 minute.
- 2** Set the MAIN Power Switch on the LCD Projector to OFF.

Positioning the LCD Projector and Screen

The screen should be positioned so that it is not directly touched by sunlight or room light as this will wash out the colors of the picture making it hard to see. When possible, close all blinds, curtains, etc. and dim the lights. Also, the LCD Projector should be at a 90° angle to the screen for the best picture results. To determine the distance for the desired size, please refer to the LCD Projector/Screen Relationship Chart below.

■ Top View

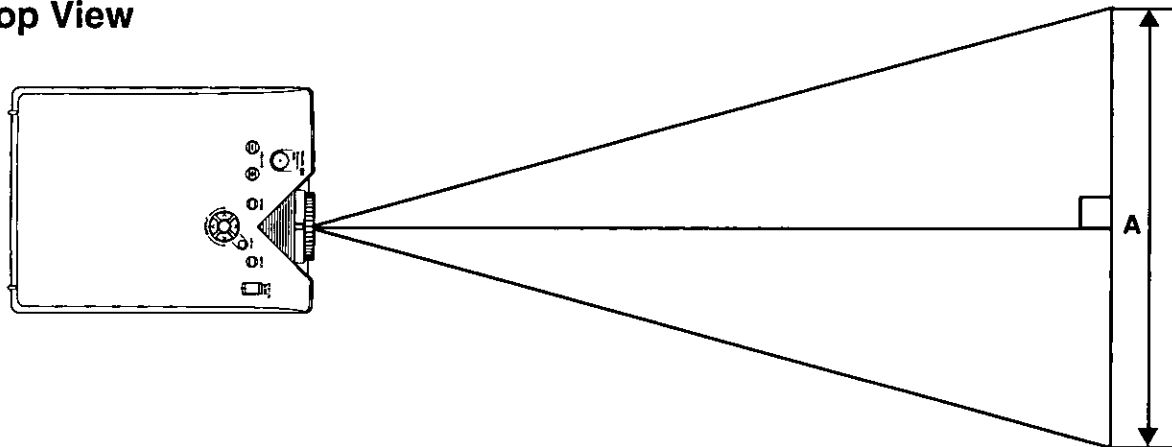

■ Side View

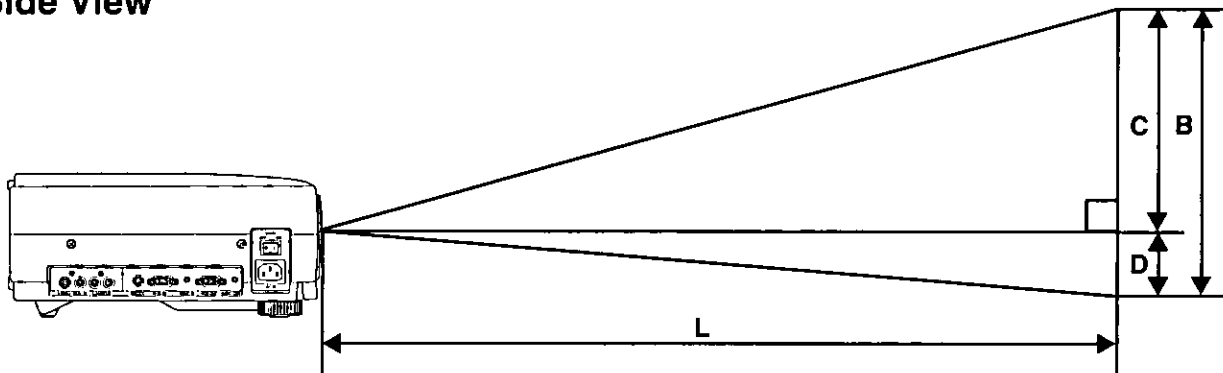

- Your LCD Projector is equipped with an image reverse feature. So, in addition to front projection, you can also reverse the image for rear projection. (See page 11.)

LCD Projector /Screen Relative Position Chart

The picture can be adjusted to the desired size within the range of the zoom lens.

(This chart is based on SVGA input signal. Screen sizes will be smaller when VGA signal is used.)

Screen size	Throw distance (L)	Measure (A)	Measure (B)	Measure (C)	Measure (D)
20 inches	3.18 ft (0.97 m)	1.35 ft (0.41 m)	0.98 ft (0.30 m)	0.89 ft (0.27 m)	1.18 in. (3 cm)
40 inches	4.59 – 6.56 ft (1.4 – 2.0 m)	2.66 ft (0.81 m)	2.00 ft (0.61 m)	1.80 ft (0.55 m)	2.36 in. (6 cm)
60 inches	6.89 – 10.17 ft (2.1 – 3.1 m)	3.94 ft (1.2 m)	2.99 ft (0.91 m)	2.69 ft (0.82 m)	3.54 in. (9 cm)
72 inches	8.20 – 12.14 ft (2.5 – 3.7 m)	4.92 ft (1.5 m)	3.61 ft (1.1 m)	3.25 ft (0.99 m)	4.33 in. (11 cm)
80 inches	9.19 – 13.45 ft (2.8 – 4.1 m)	5.25 ft (1.6 m)	3.94 ft (1.2 m)	3.54 ft (1.08 m)	4.72 in. (12 cm)
100 inches	11.48 – 17.06 ft (3.5 – 5.2 m)	6.56 ft (2.0 m)	4.92 ft (1.5 m)	4.43 ft (1.35 m)	5.91 in. (15 cm)
120 inches	13.78 – 20.67 ft (4.2 – 6.3 m)	7.87 ft (2.4 m)	5.91 ft (1.8 m)	6.79 ft (2.07 m)	7.09 in. (18 cm)
150 inches	17.39 – 25.92 ft (5.3 – 7.9 m)	9.84 ft (3.0 m)	7.55 ft (2.3 m)	5.31 ft (1.62 m)	9.06 in. (23 cm)
200 inches	23.29 – 34.78 ft (7.1 – 10.6 m)	13.45 ft (4.1 m)	9.84 ft (3.0 m)	8.86 ft (2.7 m)	11.81 in. (30 cm)
250 inches	29.20 – 43.31 ft (8.9 – 13.2 m)	16.73 ft (5.1 m)	12.47 ft (3.8 m)	11.22 ft (3.42 m)	14.96 in. (38 cm)
300 inches	35.43 – 51.84 ft (10.8 – 15.8 m)	20.01 ft (6.1 m)	15.09 ft (4.6 m)	13.58 ft (4.14 m)	18.11 in. (46 cm)

- If the LCD Projector and the screen are not properly placed, the picture will be distorted producing a keystone image as shown at right.



Caution: When you set up the LCD Projector

- Do not place it in humid or dusty places, or places where the air is sooty or full of cigarette smoke. If the lens, mirror, or other optical components become dirty, the picture will blur or darken, making viewing difficult.
- Do not expose to extreme heat or cold. Operating temperature: 5°C – 40°C (41°F – 104°F)

LCD Projector Initial Setup

Place the LCD Projector on a stable, flat surface according to the LCD Projector/Screen Relative Position Chart on page 10.

■ Positioning the LCD Projector

CAUTION: depending on the relative position of the LCD Projector and the screen, improper adjustments may cause picture distortion. To prevent the LCD Projector from wobbling, make sure both adjusters (see below) are in firm contact with the support surface.

• Side View

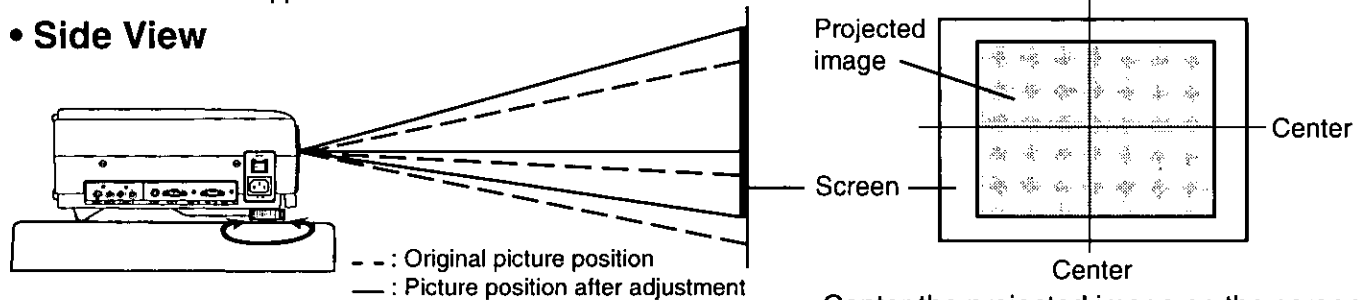

- Center the projected image on the screen.

• Front View

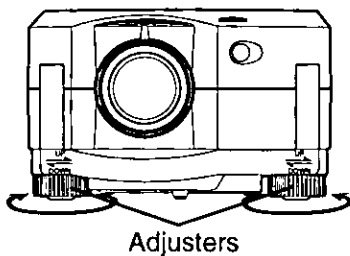

To Raise: Turn adjusters to the right.
To Lower: Turn adjusters to the left.

Note:

- For a distortion-free picture, it is very important that the LCD Projector be positioned so that it is perfectly horizontal. If necessary turn the adjusters in either direction to make fine adjustments.

■ Adjusting the lens

If the LCD Projector is not set up so that it is horizontal, it will not be possible to obtain a distortion-free picture. Turn the adjusters in either direction to make fine adjustments to the level of the projector so that the projector is perfectly horizontal.

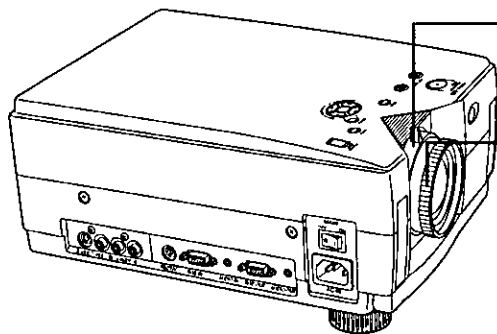

Use the **ZOOM Ring** to adjust the size of the picture.
For a larger picture, turn the ring to the right.
For a smaller picture, turn the ring to the left.

Use the **FOCUS Ring** to adjust the focus of the picture.
Turn the ring to the right or left until the picture is at the optimum focus.

■ Rear Screen Mode Projection

The image can be flipped to a mirror image of the input video signal for rear screen projection.

The procedure and on-screen displays shown below are based on RGB as the input signal.

- 1 Press **MENU** to display the menu.
- 2 Press **▲** or **▼** to select **SET UP PROJECTOR**, and then **<** or **>** to display the screen.
- 3 Press **▲** or **▼** to select **FRONT/REAR**, and then **<** or **>** to select **FRONT** or **REAR**.
 - Select **FRONT** to return to the standard projection format.
 - Select **REAR** to flip to a mirror image of the input signal.
- 4 Press **MENU** twice to exit.

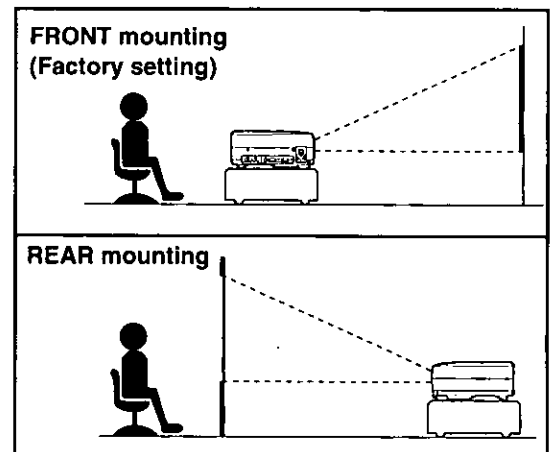
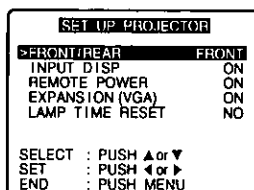
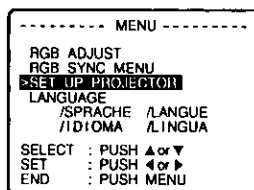

Connecting the LCD Projector

Before you begin...

- Turn off the power supply of each system component before connecting any of the components.
- If the necessary cables for connecting any of the system components are not supplied with the component or available as an optional accessory, you may need to construct them yourself.

■ Connecting to a computer (RGB signal)

Diagram numbers correspond with numbers (see page 13).

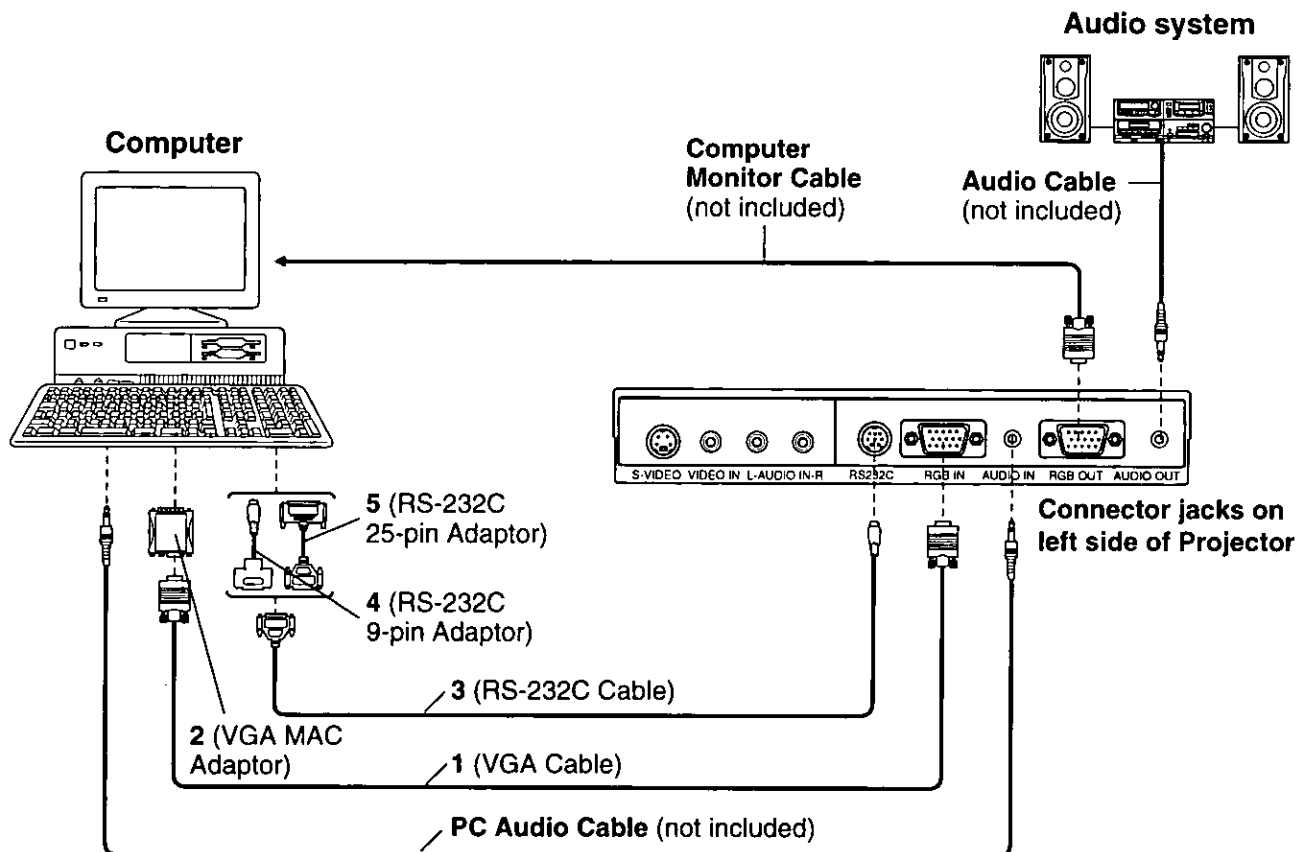

Note:

- The RGB input accepts signals from VGA, SVGA, XGA (Compression), and MAC compatible computers without the need for any additional hardware.
- Plug the VGA signal cable (supplied) correctly into the RGB IN terminal on the LCD Projector and the RGB signal Output terminal on your computer. Secure the plugs by tightening the thumb screws.

When connecting the LCD Projector to a Macintosh Series computer, first connect the VGA/MAC adaptor (supplied) to the RGB-signal input terminal on your computer. Then, firmly plug the VGA signal cable into both the RGB IN terminal on the LCD Projector and the VGA/MAC adaptor on the computer. Secure the plugs by tightening the thumb screws.

- To view images simultaneously on the monitor and projection screen, connect your computer monitor to the LCD Projector's RGB OUT terminal.
- When the LCD Projector is connected to external devices (ex. personal computer, etc.) you can use the remote control in place of the computer's mouse by attaching the RS-232C connector cable.
- Plug the RS-232C Cable (supplied) correctly into the RS-232C terminal on the LCD Projector and the RS-232C Output terminal on the computer. Secure the plugs by tightening the thumb screws.

When connecting to a Macintosh series computer, use the RS-232C 9-pin adaptor (supplied). Or, when connecting to an IBM-PC series computer, use the RS-232C 25-pin adaptor (supplied). Connect one of these RS-232C adaptor to the RS-232C input terminal on your computer. Then, firmly plug the RS-232C cable into both the RS-232C terminal on the LCD Projector and the RS-232C adaptor on the computer. Secure the plugs by tightening the screws.

- When connecting the LCD Projector to a compatible computer other than a VGA, SVGA, XGA (Compression), or Macintosh series, a separate cable is needed.
- If you wish to use the plug & play function, turn on the MAIN power switch on the LCD Projector before turning on the computer.

■ Connecting to audio/video output equipment (S-Video/Video signal)

Diagram numbers correspond with numbers (see the bottom of this page).

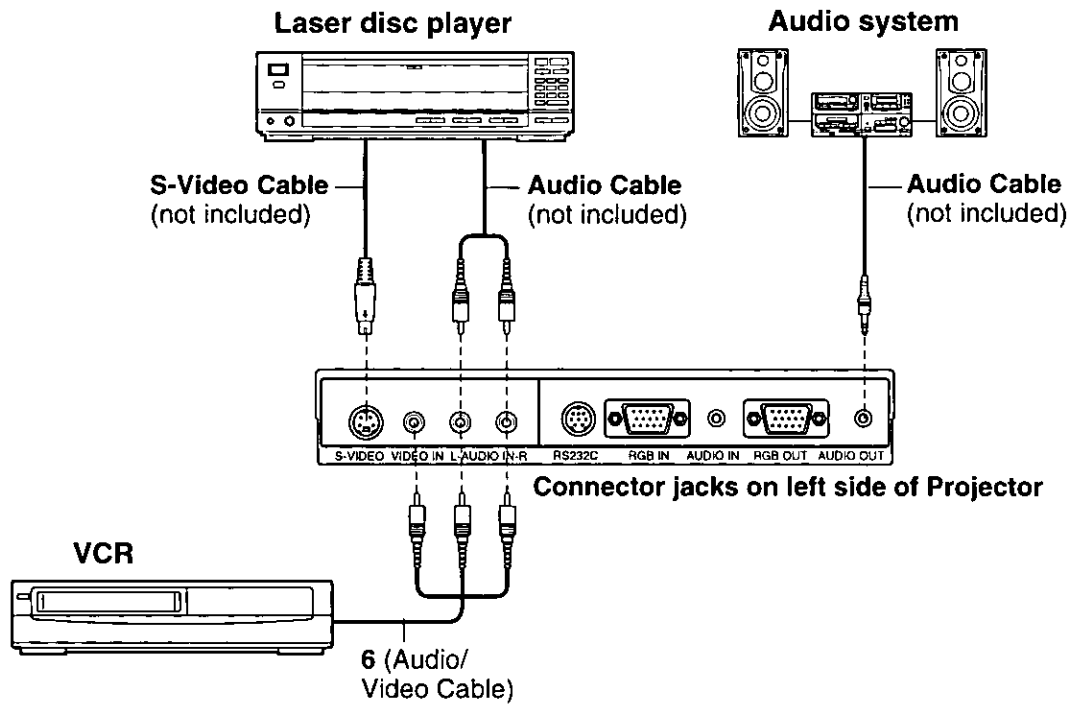









Note:

- If the S-VIDEO IN and VIDEO IN terminals are both connected, the S-VIDEO IN signal input will have priority. To view the signal being input to the VIDEO IN terminal, disconnect the plug from the S-VIDEO IN terminal.
- If the video signal source is connected using a cable with a BNC junction plug, use the BNC/RCA adaptor (not included) to convert the pin jack.

Video/ Computer Cables & Adaptors

These accessories are supplied in order to connect the LCD Projector to Computer/ AV equipment. The numbers in the left column correspond with the numbers in the connection diagrams on pages 12 - 13.

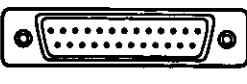
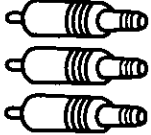
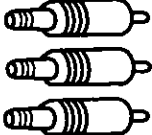
No.	CABLE/ADAPTOR	PORT		LENGTH
		Projector side	Computer/AV products side	
1	VGA Cable	D-Sub mini 15-pin (male) 	D-Sub mini 15-pin (male) 	6.56 ft (2.0 m)
2	VGA MAC Adaptor	D-Sub mini 15-pin (female) 	 MAC D-Sub 15-pin (male)	—
3	RS-232C Cable	Mini DIN 8-pin (male) 	D-Sub 9-pin (female) 	6.56 ft (2.0 m)
4	RS-232C 9-pin Adaptor	D-Sub 9-pin (male) 	 Mini DIN 8-pin (male)	—
5	RS-232C 25-pin Adaptor	D-Sub 9-pin (male) 	 D-Sub 25-pin (female)	—
6	Audio/Video Cable	RCA pin (male) X 3 	RCA pin (male) X 3 	4.92 ft (1.5 m)

Pin Assignment

Follow the instructions below when connecting to a computer. Refer to page 13 for list of cables and adaptors.

A. Signal connector: D-Sub mini 15-pin (PC/AT compatible model) Connect the signal cable to the D-Sub mini 15-pin connector on the LCD Projector unit.

B. Signal connector: D-Sub 15-pin (MAC)

To convert a MAC D-Sub 15-pin connector to a D-Sub mini 15-pin connector, connect a VGA-MAC adaptor (included) to the D-Sub 15-pin connector and then to the D-Sub mini 15-pin connector on the LCD Projector. Be sure to set the DIP switches on the VGA-MAC adaptor to your display type. (See the bottom of this page.)

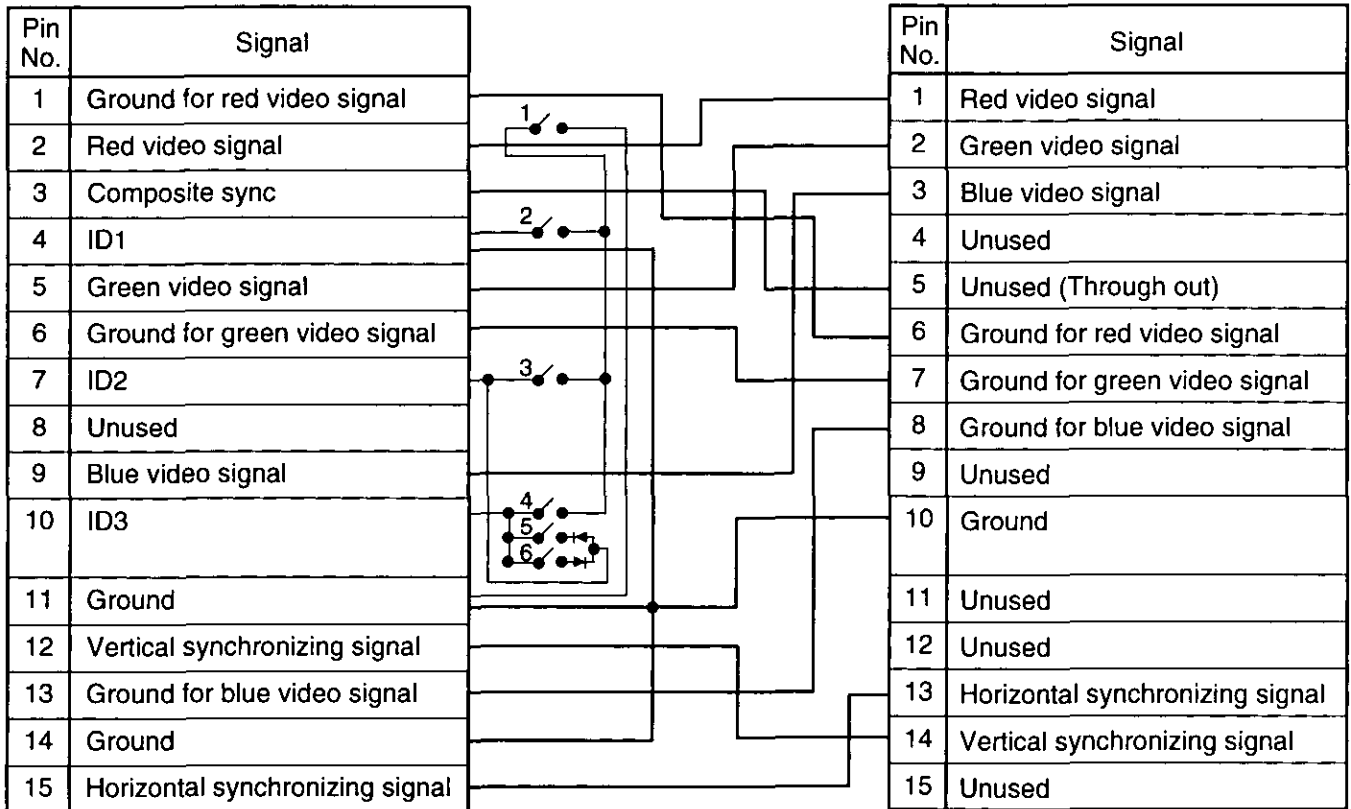
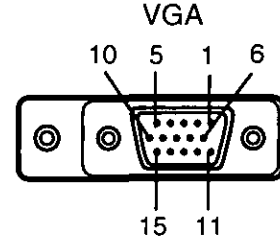
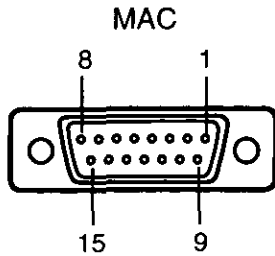

Note:

- When using a Composite Sync Output type Macintosh, please use a Composite Sync type VGA MAC Adaptor (pin 3 and pin 13 are connected).

[Setting the DIP Switches]

RESOLUTION	DIP SWITCHES					
	1	2	3	4	5	6
*21" MULTIMODE	●	●				
*17" MULTIMODE	●			●		
*13" MULTIMODE	●			●	●	
VGA/SVGA MODE						
21" 1152X870	●	●	●	●		
19" 1024X768	●	●	●	●		
16" 832X624	●	●	●	●		
13" 640X480	●	●	●	●		

LEGEND:
 ● - SUPPORTS APPLE MULTIPLE SCAN SOFTWARE
 ○ - ON

Find the resolution of your display type on the table shown left (also on the adaptor). Then, set each DIP switch that is indicated by a "●" mark to ON.

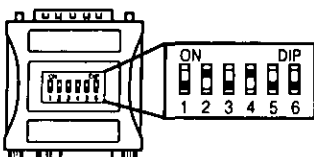

Example: If your display type is 16", set DIP switches 2 and 4 on the VGA-MAC adaptor to ON. By doing so, the signal will travel through switches 2 and 4, and Pin No. 4 to 10 as shown in the signal chart above.

C. RS-232C Connector: D-Sub 9-pin Connect the RS-232C Cable to the mini DIN 8-pin connector on the LCD Projector unit.

D. RS-232C Connector: Mini DIN 8-pin

To convert a D-Sub 9-pin connector to a mini DIN 8-pin connector, use a RS-232C 9-pin adaptor (included). Connect the D-Sub 9-pin adaptor and RS-232C cable. Then, connect it to the mini DIN 8-pin connector on the LCD Projector unit.

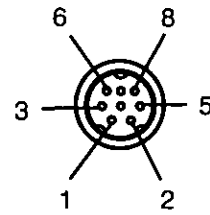
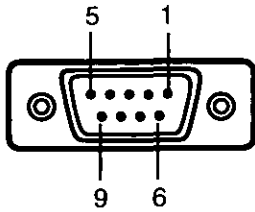

Pin No.	Signal
1	Unused
2	Received data
3	Transmitted data
4	Unused
5	Ground
6	Unused
7	Unused (Request to send)
8	Unused (Clear to send)
9	Unused

Pin No.	Signal
1	Unused (Request to send)
2	Unused (Clear to send)
3	Transmitted data
4	Ground
5	Received data
6	Unused
7	Unused
8	Unused

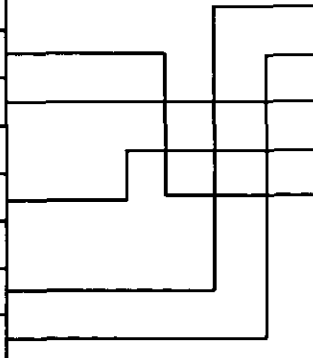

E. RS-232C connector: D-Sub 25-pin

To convert a D-Sub 25-pin connector to a D-Sub 9-pin connector, use a RS-232C 25-pin adaptor (included). Connect the D-Sub 25-pin adaptor and RS-232C cable. And then connect it to the D-Sub 9-pin connector on the LCD Projector unit.

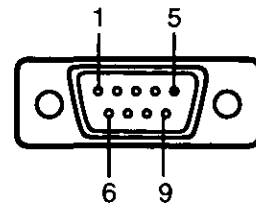
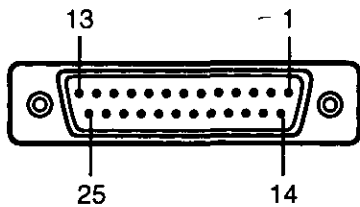

Pin No.	Signal
1	Unused
2	Transmitted data
3	Received data
4	Unused (Request to send)
5	Unused (Clear to send)
6	Unused
7	Ground
8-25	Open

Pin No.	Signal
1	Unused
2	Received data
3	Transmitted data
4	Unused
5	Ground
6	Unused
7	Unused (Request to send)
8	Unused (Clear to send)
9	Unused

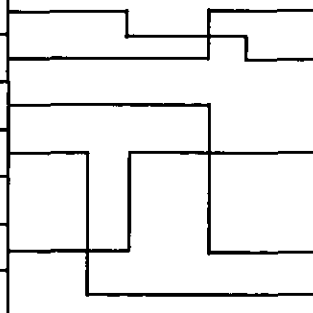

Factory Preset Timing

		Preset timing		
		IBM 640 X 350 at 70 Hz	IBM 640 X 400 at 70 Hz	IBM 640 X 480 at 60 Hz
DOT CLOCK		25.1745 MHz	25.1745 MHz	25.1745 MHz
H O R I Z	f H	31.4681 KHz	31.4681 KHz	31.4681 KHz
	A - PERIOD	31.778 μ s (800 dots)	31.778 μ s (800 dots)	31.778 μ s (800 dots)
	B - BLANKING	6.356 μ s (160 dots)	6.356 μ s (160 dots)	6.356 μ s (160 dots)
	C - SYNC WIDTH	3.813 μ s (96 dots)	3.813 μ s (96 dots)	3.813 μ s (96 dots)
	D - BACK PORCH	1.907 μ s (48 dots)	1.907 μ s (48 dots)	1.907 μ s (48 dots)
	E - ACTIVE TIME	25.423 μ s (640 dots)	25.423 μ s (640 dots)	25.423 μ s (640 dots)
	F - FRONT PORCH	0.636 μ s (16 dots)	0.636 μ s (16 dots)	0.636 μ s (16 dots)
V E R T	f V	70.0849 Hz	70.0849 Hz	59.939 Hz
	A - PERIOD	14.268 ms (449 lines)	14.268 ms (449 lines)	16.684 ms (525 lines)
	B - BLANKING	3.146 ms (99 lines)	1.557 ms (49 lines)	1.430 ms (45 lines)
	C - SYNC WIDTH	0.064 ms (2 lines)	0.064 ms (2 lines)	0.064 ms (2 lines)
	D - BACK PORCH	1.907 ms (60 lines)	1.112 ms (35 lines)	1.049 ms (33 lines)
	E - ACTIVE TIME	11.122 ms (350 lines)	12.711 ms (400 lines)	15.254 ms (480 lines)
	F - FRONT PORCH	1.176 ms (37 lines)	0.381 ms (12 lines)	0.318 ms (10 lines)
SYNC POLARITY (H/V)		Positive / Negative	Negative / Positive	Negative / Negative

		Reservation timing	Preset timing	
		MAC LC 640 X 480	MAC II 640 X 480	VESA 640 X 350 at 85 Hz
DOT CLOCK		31.334 MHz	30.2410 MHz	31.5 MHz
H O R I Z	f H	34.97 KHz	35.0012 KHz	37.861 KHz
	A - PERIOD	28.598 μ s (896 dots)	28.570 μ s (864 dots)	26.413 μ s (832 dots)
	B - BLANKING	8.171 μ s (256 dots)	7.407 μ s (224 dots)	6.095 μ s (192 dots)
	C - SYNC WIDTH	2.043 μ s (64 dots)	2.803 μ s (63 dots)	2.032 μ s (64 dots)
	D - BACK PORCH	2.426 μ s (76 dots)	3.241 μ s (98 dots)	3.048 μ s (96 dots)
	E - ACTIVE TIME	20.425 μ s (640 dots)	21.163 μ s (640 dots)	20.317 μ s (640 dots)
	F - FRONT PORCH	3.702 μ s (116 dots)	2.083 μ s (63 dots)	1.016 μ s (32 dots)
V E R T	f V	66.61 Hz	66.6689 Hz	85.080 Hz
	A - PERIOD	15.013 ms (525 lines)	15.000 ms (525 lines)	11.754 ms (445 lines)
	B - BLANKING	1.287 ms (45 lines)	1.286 ms (45 lines)	2.509 ms (95 lines)
	C - SYNC WIDTH	0.086 ms (3 lines)	0.086 ms (3 lines)	0.079 ms (3 lines)
	D - BACK PORCH	1.115 ms (39 lines)	1.114 ms (39 lines)	1.585 ms (60 lines)
	E - ACTIVE TIME	13.726 ms (480 lines)	13.714 ms (480 lines)	9.244 ms (350 lines)
	F - FRONT PORCH	0.886 ms (3 lines)	0.086 ms (3 lines)	0.845 ms (32 lines)
SYNC POLARITY (H/V)		Negative / Negative	Sync on Green or Composit	Positive / Negative

		Preset timing		
		VESA 640 X 400 at 85 Hz	VESA 640 X 480 at 72 Hz	VESA 640 X 480 at 75 Hz
DOT CLOCK		31.5 MHz	31.5 MHz	31.5 MHz
H O R I Z	f H	37.861 KHz	37.861 KHz	37.500 KHz
	A - PERIOD	26.413 μ s (832 dots)	26.413 μ s (832 dots)	26.667 μ s (840 dots)
	B - BLANKING	6.095 μ s (192 dots)	6.095 μ s (192 dots)	6.349 μ s (200 dots)
	C - SYNC WIDTH	2.032 μ s (64 dots)	1.270 μ s (40 dots)	2.032 μ s (64 dots)
	D - BACK PORCH	3.048 μ s (96 dots)	4.063 μ s (128 dots)	3.810 μ s (120 dots)
	E - ACTIVE TIME	20.317 μ s (640 dots)	20.317 μ s (640 dots)	20.317 μ s (640 dots)
	F - FRONT PORCH	1.016 μ s (32 dots)	0.762 μ s (24 dots)	0.508 μ s (16 dots)
V E R T	f V	85.080 Hz	72.8088 Hz	75.0000 Hz
	A - PERIOD	11.754 ms (445 lines)	13.735 ms (520 lines)	13.333 ms (500 lines)
	B - BLANKING	1.189 ms (45 lines)	1.057 ms (40 lines)	0.533 ms (20 lines)
	C - SYNC WIDTH	0.079 ms (3 lines)	0.079 ms (3 lines)	0.080 ms (3 lines)
	D - BACK PORCH	1.083 ms (41 lines)	0.740 ms (28 lines)	0.427 ms (16 lines)
	E - ACTIVE TIME	10.565 ms (400 lines)	12.678 ms (480 lines)	12.800 ms (480 lines)
	F - FRONT PORCH	0.026 ms (1 line)	0.238 ms (9 lines)	0.027 ms (1 line)
SYNC POLARITY (H/V)		Negative / Positive	Negative / Negative	Negative / Negative

		Preset timing		
		VESA 640 X 480 at 85Hz	VESA 800 X 600 at 56Hz	VESA 800 X 600 at 60Hz
DOT CLOCK		36.000 MHz	36.000 MHz	40.000 MHz
H O R I Z	fH	43.269 KHz	35.156 KHz	37.879 KHz
	A - PERIOD	23.111 μ s (832 dots)	28.444 μ s (1024 dots)	26.400 μ s (1056 dots)
	B - BLANKING	5.333 μ s (192 dots)	6.222 μ s (224 dots)	6.400 μ s (256 dots)
	C - SYNC WIDTH	1.333 μ s (48 dots)	2.000 μ s (72 dots)	3.200 μ s (128 dots)
	D - BACK PORCH	3.111 μ s (112 dots)	3.556 μ s (128 dots)	2.200 μ s (88 dots)
	E - ACTIVE TIME	17.778 μ s (640 dots)	22.222 μ s (800 dots)	20.000 μ s (800 dots)
	F - FRONT PORCH	0.889 μ s (32 dots)	0.667 μ s (24 dots)	1.000 μ s (40 dots)
V E R T	fV	85.008 Hz	56.250 Hz	60.317 Hz
	A - PERIOD	11.764 ms (509 lines)	17.778 ms (625 lines)	16.579 ms (628 lines)
	B - BLANKING	0.670 ms (29 lines)	0.711 ms (25 lines)	0.739 ms (28 lines)
	C - SYNC WIDTH	0.069 ms (3 lines)	0.057 ms (2 lines)	0.106 ms (4 lines)
	D - BACK PORCH	0.578 ms (25 lines)	0.626 ms (22 lines)	0.607 ms (23 lines)
	E - ACTIVE TIME	11.093 ms (480 lines)	17.067 ms (600 lines)	15.840 ms (600 lines)
	F - FRONT PORCH	0.023 ms (1 line)	0.028 ms (1 line)	0.026 ms (1 line)
SYNC POLARITY (H/V)		Negative / Negative	Positive / Positive	Positive / Positive

		Preset timing		
		VESA 800 X 600 at 72Hz	VESA 800 X 600 at 75Hz	VESA 800 X 600 at 85Hz
DOT CLOCK		50.000 MHz	49.500 MHz	56.250 MHz
H O R I Z	fH	48.077 KHz	46.875 KHz	53.674 KHz
	A - PERIOD	20.800 μ s (1040 dots)	21.333 μ s (1056 dots)	18.631 μ s (1048 dots)
	B - BLANKING	4.800 μ s (240 dots)	5.172 μ s (256 dots)	4.409 μ s (248 dots)
	C - SYNC WIDTH	2.400 μ s (120 dots)	1.616 μ s (80 dots)	1.138 μ s (64 dots)
	D - BACK PORCH	1.280 μ s (64 dots)	3.232 μ s (160 dots)	2.702 μ s (152 dots)
	E - ACTIVE TIME	16.000 μ s (800 dots)	16.162 μ s (800 dots)	14.222 μ s (800 dots)
	F - FRONT PORCH	1.120 μ s (56 dots)	0.323 μ s (16 dots)	0.569 μ s (32 dots)
V E R T	fV	72.188 Hz	75.000 Hz	85.061 Hz
	A - PERIOD	13.853 ms (666 lines)	13.333 ms (625 lines)	11.756 ms (631 lines)
	B - BLANKING	1.373 ms (66 lines)	0.533 ms (25 lines)	0.578 ms (31 lines)
	C - SYNC WIDTH	0.125 ms (6 lines)	0.064 ms (3 lines)	0.056 ms (3 lines)
	D - BACK PORCH	0.478 ms (23 lines)	0.448 ms (21 lines)	0.503 ms (27 lines)
	E - ACTIVE TIME	12.480 ms (600 lines)	12.800 ms (600 lines)	11.179 ms (600 lines)
	F - FRONT PORCH	0.770 ms (37 lines)	0.021 ms (1 line)	0.019 ms (1 line)
SYNC POLARITY (H/V)		Positive / Positive	Positive / Positive	Positive / Positive

		Preset timing (* Compression)	
		MAC 16" 832 X 624	MAC 19" 1024 X 768
		57.283 MHz	80.0000 MHz
H O R I Z	fH	49.725 KHz	60.2410 KHz
	A - PERIOD	20.111 μ s (1152 dots)	16.600 μ s (1328 dots)
	B - BLANKING	5.587 μ s (320 dots)	3.800 μ s (304 dots)
	C - SYNC WIDTH	1.117 μ s (64 dots)	1.200 μ s (96 dots)
	D - BACK PORCH	3.910 μ s (244 dots)	2.200 μ s (176 dots)
	E - ACTIVE TIME	14.524 μ s (832 dots)	12.800 μ s (1024 dots)
	F - FRONT PORCH	0.559 μ s (32 dots)	0.400 μ s (4 dots)
V E R T	fV	74.550 Hz	74.9266 Hz
	A - PERIOD	13.414 ms (667 lines)	13.346 ms (804 lines)
	B - BLANKING	0.865 ms (43 lines)	0.597 ms (36 lines)
	C - SYNC WIDTH	0.060 ms (3 lines)	0.050 ms (3 lines)
	D - BACK PORCH	0.784 ms (39 lines)	0.498 ms (30 lines)
	E - ACTIVE TIME	12.549 ms (624 lines)	12.749 ms (768 lines)
	F - FRONT PORCH	0.020 ms (1 line)	0.050 ms (3 lines)
SYNC POLARITY (H/V)		Negative/Negative	-----

*Note: Because some lines are omitted, picture degradation may occur.

Basic LCD Projector Operation

Before you begin, make sure...

- You have read Important Safeguards. (See pages 3, 4.)
- All connections are made. (See pages 12, 13.)
- LCD Projector is positioned properly. (See page 10.)
- LCD Projector is plugged in.
- Lens cap is removed.

<LCD Projector>

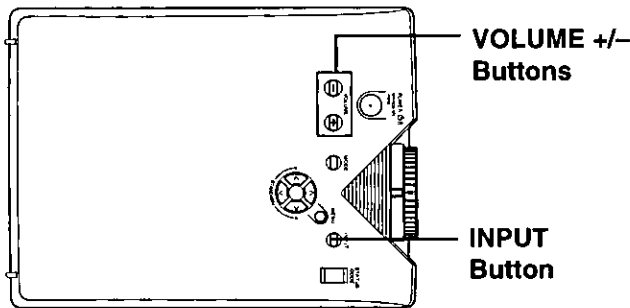

<Remote Control>

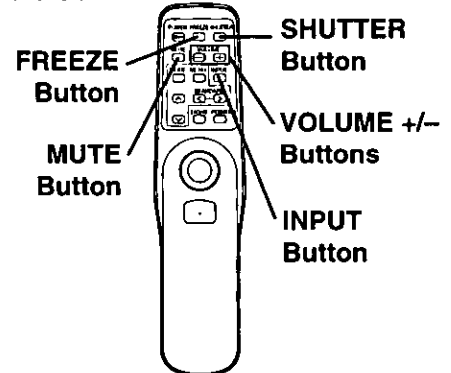

1 Turn on the Power.

(See "Turning the power on and off" on page 9.)

2 Press INPUT on the LCD Projector or remote control to select the desired input signal.

- Continue to press INPUT to set the desired input signal. Each press will change the display as shown below.

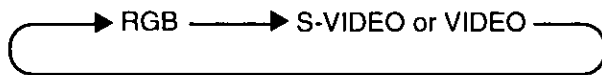

- If unit is connected with both S-VIDEO and VIDEO cables, the S-VIDEO signal has priority.
- You may turn the input signal display off. (See "Turning off the input signal display" on page 20.)

3 Turn on your computer (RGB) or start video playback (S-Video or Video).

- Adjust FOCUS and ZOOM Rings if necessary. (See "Adjusting the lens" on page 11.)

4 Press VOLUME +/- on the LCD Projector or remote control to adjust the volume level of the built-in speaker.

- The number of segments (0 - 63) increases or decreases as the volume is adjusted.

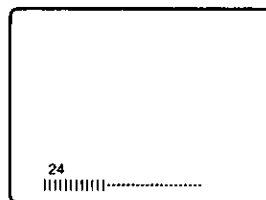

[When you select S-VIDEO or VIDEO input signal.]

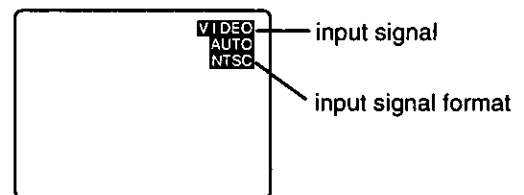

Note:

- When S-VIDEO or VIDEO input signal is selected, the name of the signal format will be displayed directly below the input signal in the on screen display.

Special effects while projecting

- **Turning off the sound**
Press the MUTE Button to instantly mute the sound.
Press again to restore the previous sound level.
- **Manual Shutter Function**
Press the SHUTTER Button to blank out the video and mute the sound.
Press again to return to the normal screen and sound.
- **Freeze the picture**
Press the FREEZE Button to freeze the picture and mute the sound.
Press again to return to the normal screen and sound.

Using other useful functions

You may use buttons on the LCD Projector or remote control for the following operations.

■ Selecting the Video System Format

The LCD Projector is equipped with full NTSC, PAL, SECAM, PAL-M, PAL-N, and NTSC4.43 video support. Usually set to AUTO, the broadcast format is automatically switched according to the tape inserted. If you experience poor color however, you may have to set to NTSC, PAL, SECAM, PAL-M, PAL-N, and NTSC4.43 as described below.

S-Video/ Video input is selected (page 19).

- 1 Press **MENU** to display the menu.
- 2 Press **▲** or **▼** to select VIDEO SYSTEM, and then **<** or **>** to display the screen.
- 3 Press **▲** or **▼** to select the desired video system.
- 4 Press **MENU** twice to exit.

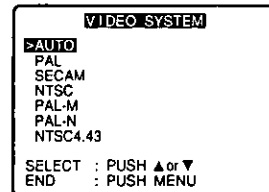
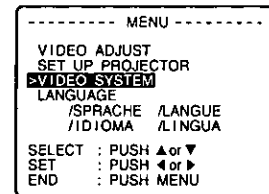

■ Selecting the Language for On-Screen Displays

The LCD Projector can display screens in one of five different languages. The procedure and on-screen displays shown below are based on RGB as the input signal.

- 1 Press **MENU** to display the menu.
- 2 Press **▲** or **▼** to select LANGUAGE, and then **<** or **>** to display the screen.
- 3 Press **▲** or **▼** to select the language.
- 4 Press **MENU** twice to exit.

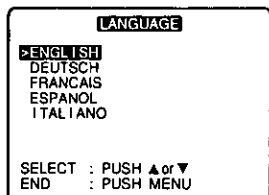
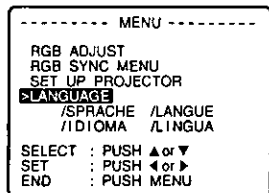

■ Turning off the input signal display

The function which displays the currently selected input signal on the screen can be turned off by the following procedure.

The procedure and on-screen displays shown below are based on RGB as the input signal.

- 1 Press **MENU** to display the menu.
- 2 Press **▲** or **▼** to select SET UP PROJECTOR, and then **<** or **>** to display the screen.
- 3 Press **▲** or **▼** to select INPUT DISP, and then **<** or **>** to select ON or OFF.
 - Select OFF to turn off the input signal display function.
 - Select ON to turn the input signal display function. The input signal will be displayed each time it is changed. (This is the factory setting.)
- 4 Press **MENU** twice to exit.

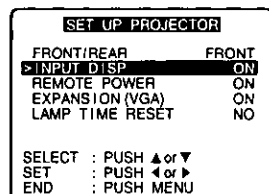
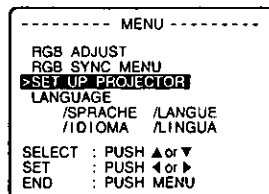

■ Disabling the POWER button on the remote control

In order to prevent the power being turned off by mistake, the POWER button on the remote control can be disabled by the following procedure.

The procedure and on-screen displays shown below are based on RGB as the input signal.

- 1 Press **MENU** to display the menu.
- 2 Press **▲** or **▼** to select SET UP PROJECTOR, and then **<** or **>** to display the screen.
- 3 Press **▲** or **▼** to select REMOTE POWER, and then **<** or **>** to select ON or OFF.
 - Select OFF to disable the POWER button on the remote control.
 - Select ON to use the POWER button on the remote control normally. (This is the factory setting.)
- 4 Press **MENU** twice to exit.

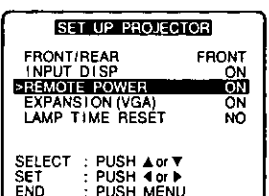
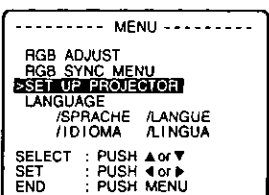

■ To cancel enlarging (Scanning Line Conversion) Function

When a S-VIDEO/VIDEO signal in NTSC format or a signal less than 800 X 600 dots signals (Ex. 640 X 480 dots) is input, the LCD Projector automatically enlarges the image to 800 X 600 dots.

This may cause picture quality degradation. For better image, select EXPANSION (VGA) or (NTSC):OFF by the following procedure.

The procedure and on-screen displays shown below are based on RGB as the input signal.

- 1 Press **MENU** to display the menu.
- 2 Press **▲** or **▼** to select **SET UP PROJECTOR**, and then **<** or **>** to display the screen.
- 3 Press **▲** or **▼** to select **EXPANSION (VGA) or (NTSC)**, and then **<** or **>** to select **ON** or **OFF**.
 - Select **OFF** to cancel enlarge (scanning line conversion) function.
 - Select **ON** to use enlarge (scanning line conversion) function. (This is the factory setting.)
- 4 Press **MENU** twice to exit.

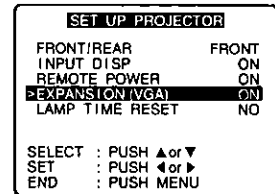
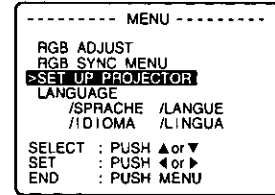

■ To change to 16:9 (Wide) screen

When a S-VIDEO or VIDEO signals in NTSC format is input, the image can be displayed in 16:9 (wide) screen by the following procedure.

S-Video/ Video input is selected (page 19).

- 1 Press **MENU** to display the menu.
- 2 Press **▲** or **▼** to select **SET UP PROJECTOR**, and then **<** or **>** to display the screen.
- 3 Press **▲** or **▼** to select **16:9 (NTSC)**, and then **<** or **>** to select **ON** or **OFF**.
 - Select **OFF** to return the normal screen. (This is the factory setting.)
 - Select **ON** to display in 16:9 (wide) screen.
- 4 Press **MENU** twice to exit.

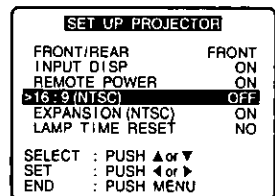
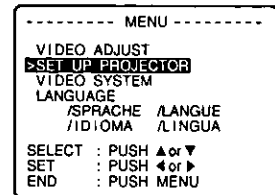

Note:

- Even if the 16:9 (wide) screen feature is set to OFF, when an "S1" signal is input, the image is automatically displayed in 16:9 (wide) screen.

■ Blue Screen with No Input Signal

The LCD Projector is equipped with an internal Blue Screen function which turns the screen blue when the video or computer equipment connected to the input jack is turned off, or when there is nothing connected to the input jack.

- If the power is turned on when no input signal is input to the LCD Projector, the screen will turn blue.

The "FOCUS" overlay appears only until the video or computer equipment is connected to the input jack and turned on. If no input signal is received (the screen is blue) for 15 minutes, the lamp will turn off automatically.
- The at right display will appear when the RGB input is within the LCD Projector's frequency range, but is not one of the LCD Projector's programmed formats. (As found on pages 16 - 18.)
- Should an RGB signal be input which is out of the LCD Projector's frequency range, no indication will be present.

[5 Minutes before power is shut off.]

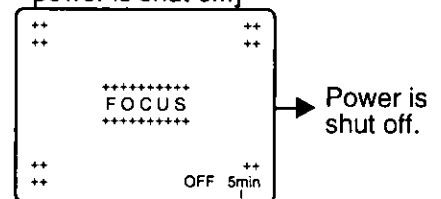

Remaining time

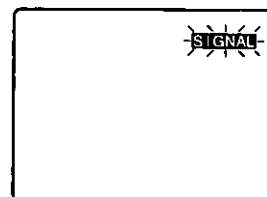

Projected Image Adjustment

This LCD projector's picture is set to standard specifications at the factory. However, you can adjust the image to suit your own preferences by using the RGB or VIDEO ADJUST feature. Three memory modes allow you to adjust and save up to three sets of settings for each input signal (RGB and S-VIDEO/VIDEO).

For RGB signal input, three items can be adjusted: "BRIGHTNESS", "PICTURE", and "COLOR (White Balance)". For video signal input, six items can be adjusted: "COLOR", "TINT", "BRIGHTNESS", "PICTURE", "SHARPNESS" and SUB COLOR (White Balance)".

Input Image Adjustment

RGB or S-VIDEO/VIDEO input is selected (page 19). Use buttons on the LCD Projector or remote control.

<LCD Projector>

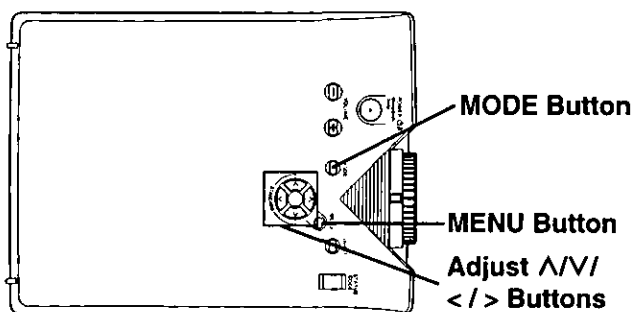

<Remote Control>

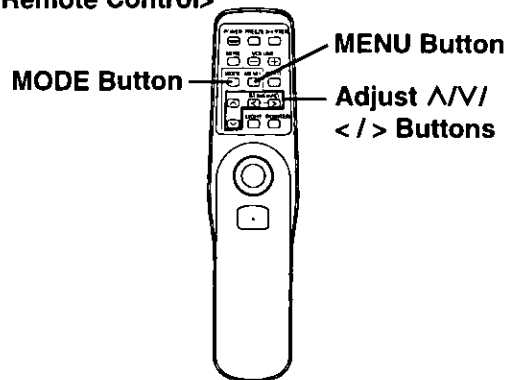

- 1** Press **MENU** to display the menu.
- 2** Press **^** or **V** to select RGB ADJUST or VIDEO ADJUST, and **<** or **>** to display the screen.
 - 3 different sets of control adjustments can be memorized for different projection situations.
- 3** Press **MODE** repeatedly to choose one of the three memory modes for adjustment (page 24).
- 4** Press **^** or **V** to select, and **<** or **>** to display the item to be adjusted.
- 5** Press **<** or **>** to adjust as described below.
 - The setting will be displayed by numerals and a bar.
- 6** Press **MENU** once to return to the RGB or VIDEO adjust menu, or **three times** to exit.

[RGB]

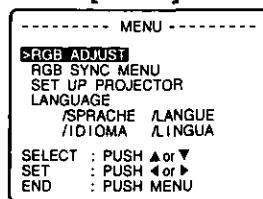

[S-VIDEO/VIDEO]

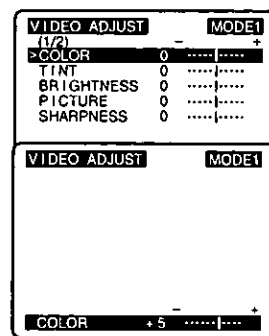
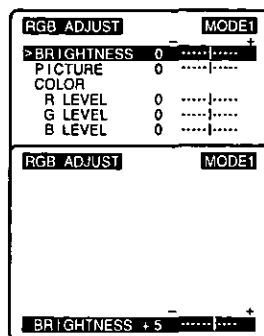
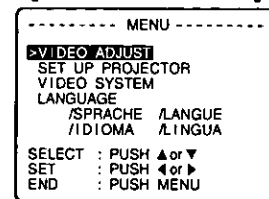

Adjustments for Input Image

- **COLOR Control** (Adjust color intensity level.)*
Press > to deepen the color.
Press < to make the color paler.
- **TINT Control** (Adjust hue for realistic tones.)*
Press > for more green.
Press < for more purple.
[Tint can be adjusted when LCD Projector is set to NTSC, or NTSC4.43 video formats.]
- **BRIGHTNESS Control** (Adjust black level to room brightness.)
Press > to brighten the image.
Press < to darken the background.
- **PICTURE Control** (Adjust overall picture intensity.)
Press > for a stronger picture.
Press < for a fainter picture.

- **SHARPNESS Control** (Adjust picture sharpness.)*
Press > to sharpen the edges of the image.
Press < to soften the edges of the image.
- **COLOR or SUB COLOR (White Balance) Control**
See page 24 for details.

Recall Standard Settings

Press < and > together. If the menu showing all items is displayed, all items will be reset. If a single item is displayed, only that item will be reset.

*: For S-VIDEO or VIDEO mode only.

■ RGB Sync Adjustment

For V POSI, H POSI, H SIZE and PHASE adjustments, see the PC output timing relative value chart below. These adjustments are automatically done when the Auto Setup feature of the ProMouse driver software is used. See "ProMouse Control feature" on page 25. RGB input is selected (page 19). Use buttons on the LCD Projector or remote control.

<LCD Projector>

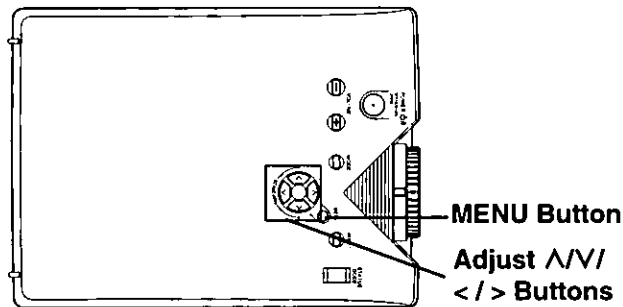

<Remote Control>

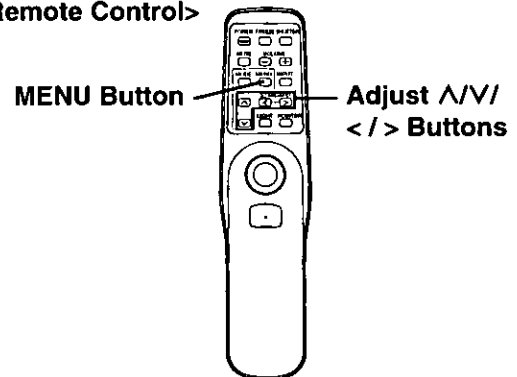

- 1 Press **MENU** to display the menu.
- 2 Press **^** or **V** to select RGB SYNC MENU, and **<** or **>** to display the screen.
- 3 Press **^** or **V** to select, and **<** or **>** to display the item to be adjusted.
- 4 Press **^** or **V** to adjust as described below.
 - The setting will be displayed by numerals and a bar.
- 5 Press **MENU** once to return to the RGB SYNC MENU menu, or three times to exit.

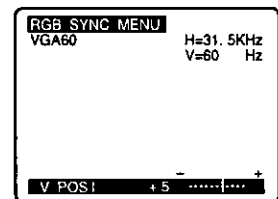
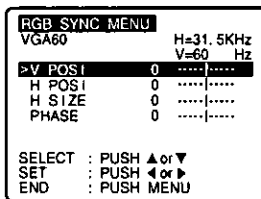
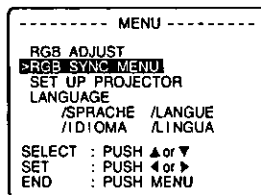

Adjustments for RGB Input

- **V POSI (Vertical Position) Control**
(Adjust vertical position within projected screen.)
Press **<** to move down or **>** to move up.

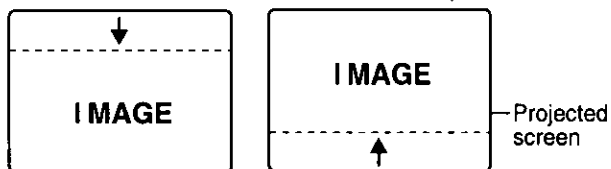

- **H POSI (Horizontal Position) Control**
(Adjust horizontal position within projected screen.)
Press **<** to move left or **>** to move right.

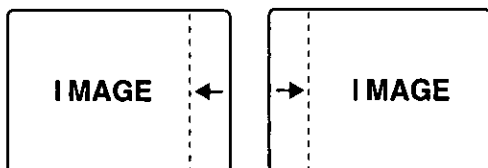

- **H (Horizontal) SIZE Control**
(Adjust data display, timing, and attain the correct horizontal image size.)
Press **<** or **>** to eliminate the vertical stripes that appear on computer screens.

- **PHASE Control**
(Adjust vertical line strength so that text is readable.)
Press **<** or **>** to eliminate the flicker (localised noise) that appears on computer screens.

• PC Output Timing Relative Value Chart

Model	Vertical Position	Horizontal Position	Horizontal size
IBM 640 X 350 at 70 Hz/ IBM 640 X 400 at 70 Hz	-30 - +30	-50 - +50	-50 - +90
IBM 640 X 480 at 60 Hz	-30 - +30	-50 - +50	-50 - +90
MAC II 640 X 480	-30 - +30	-50 - +50	-50 - +90
MAC 16" 832 X 624	-30 - +30	-50 - +50	-50 - +90
VESA 640 X 350 at 85 Hz/ VESA 640 X 400 at 85 Hz	-30 - +30	-50 - +50	-50 - +90
VESA 640 X 480 at 72 Hz	-26 - +30	-50 - +50	-50 - +90
VESA 640 X 480 at 75 Hz	-14 - +30	-50 - +50	-50 - +90
VESA 640 X 480 at 85 Hz	-23 - +30	-50 - +50	-50 - +90
VESA 800 X 600 at 56 Hz	-19 - +30	-50 - +50	-50 - +90
VESA 800 X 600 at 60 Hz	-22 - +30	-50 - +50	-50 - +90
VESA 800 X 600 at 72 Hz	-24 - +30	-50 - +50	-50 - +90
VESA 800 X 600 at 75 Hz	-19 - +30	-50 - +50	-50 - +90
VESA 800 X 600 at 85 Hz	-25 - +30	-50 - +50	-50 - +90
VESA 1024 X 768 at 60 Hz	-30 - +30	-50 - +50	-50 - +90
VESA 1024 X 768 at 70 Hz	-30 - +30	-50 - +50	-50 - +90
VESA 1024 X 768 at 75 Hz	-29 - +30	-50 - +50	-50 - +90
MAC 19" 1024 X 768	-27 - +30	-50 - +50	-50 - +90

■ Adjusting the White Balance

The picture may become over-saturated with red or blue color. Also, the white color may not be the desired degree of whiteness. In such cases, you may adjust the white balance by the following procedure.

RGB or S-VIDEO/VIDEO input is selected (page 19). Use button on the LCD Projector or remote control.

<LCD Projector>

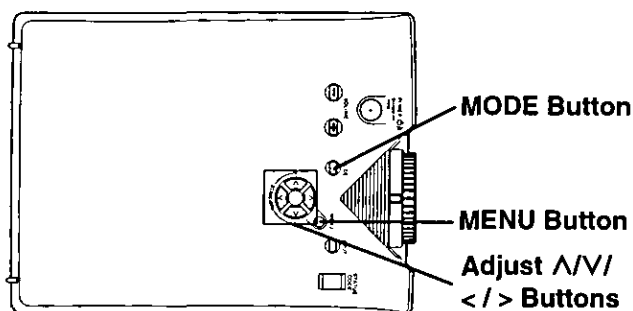

<Remote Control>

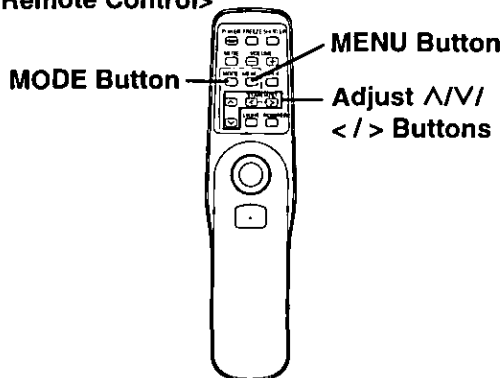

- 1 Press **MENU** to display the menu.
- 2 Press **^** or **V** to select RGB ADJUST or VIDEO ADJUST, and **<** or **>** to display the screen.
 - 3 different sets of control adjustments can be memorized for different projection situations.

- 3 Press **MODE** repeatedly to choose one of the three memory modes for adjustment as described in "selecting the Picture Memory" below.

- 4 Press **^** or **V** to select R LEVEL, G LEVEL, or B LEVEL of the COLOR (for RGB input) or SUB COLOR (for S-VIDEO/VIDEO input).

- 5 Press **<** or **>** to display the R, G, or B LEVEL adjust screen.

- 6 Press **<** or **>** to adjust the R, G, or B level.
 - The setting will be displayed by numerals and a bar.

Example of Adjustment: R LEVEL

Press **>** to strengthen the red component.
Press **<** to weaken the red component.

- 7 Press **MENU** once to return the RGB input level menu, or **three times** to exit.

[RGB]

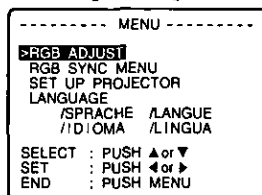

[S-VIDEO/VIDEO]

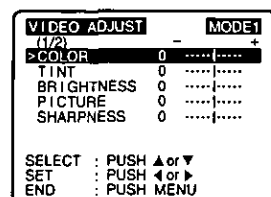
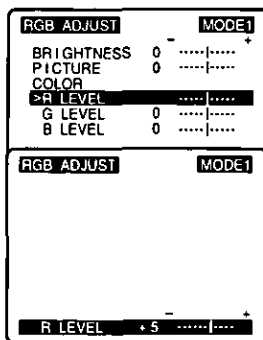
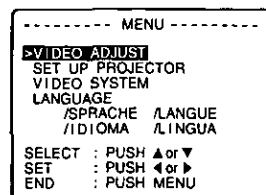

Press **^** or **V** until SUB COLOR is displayed.

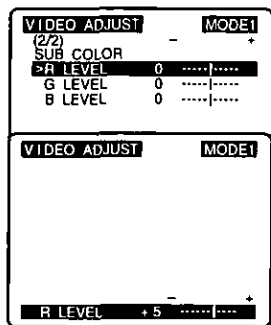

■ Selecting the Picture Memory

Press **MODE** on the LCD Projector or remote control to select the desired picture mode.

- When **MODE** is pressed, the preset setting will first be displayed on the screen for about 5 seconds.
- Each time you press **MODE**, the display will change as shown below:



ProMouse Control Feature

This feature allows you to use the LCD Projector remote control as a mouse to control your personal computer. There is also an Auto Setup feature which identifies the signal mode and automatically adjusts the Vertical position, Horizontal position, Horizontal size and Phase.

Windows 95

System Requirements:

- IBM PC/AT or compatible
- MS-Windows 95
- 386SX CPU or higher
- RAM: 8MB on-board memory
- 2MB available hard disk space
- 3.5 inch 1.44MB floppy disk drive (for installation)
- RS-232C serial port
- Mouse

Note:

- It is possible that the above Software will not operate correctly according to the Hardware circumstances of the used PC (Personal Computer) and common use of the Application software.
- Specifications of these Software are subject to change without notice.

■ ProMouse Driver Installation

1 Turn on the PC (Personal Computer) and start up Windows.

2 Insert the floppy disk (ProMouse driver software) into a floppy disk drive.

3 Select [Run...] from the Windows 95 Start menu.



4 Type in [a:\Setup.exe] and click OK.

- It is assumed that your 3.5 inch 1.44MB floppy disk drive is assigned as "A" drive. If not, replace "A" with the appropriate letter.

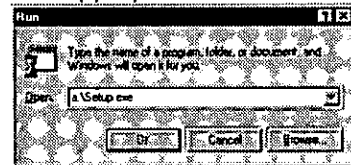

5 Follow the instructions as they appear on your PC screen. (Windows 95 is used as the example in the figures.)

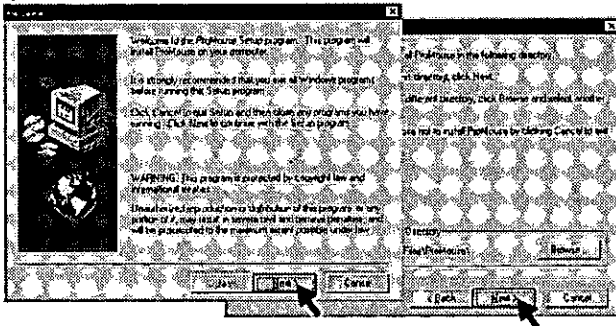

Click [OK].

■ To Open the ProMouse Software

Select [Programs]→[ProMouse]→[ProMouse] from the Windows 95 Start Menu.

- The ProMouse Menu screen will appear.

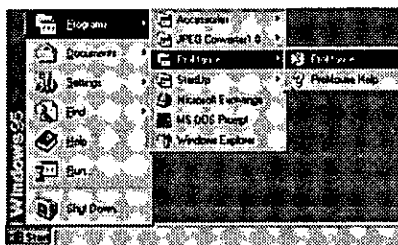

■ Using ProMouse Driver Software

The setting window at right will appear when ProMouse Driver Software is started up.

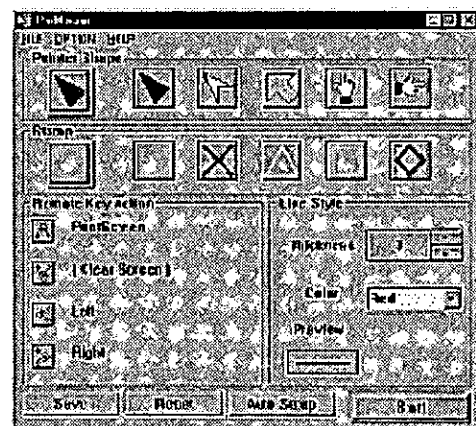

To start the ProMouse Control feature

Follow the steps below. Please refer to "ProMouse Software Details" (below) for detailed settings.

1 Select the Option→Communication Setting.

- Select and set COM1 or COM2.

2 Click Start in the lower right corner of the setting window.

The ProMouse Control feature will start and the setting window will be minimized.

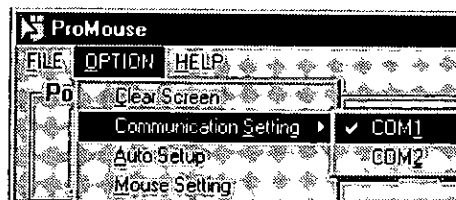

To Use the Auto Setup feature

The signal mode is identified and the Vertical position, Horizontal position, Horizontal size and Phase are automatically adjusted. Click on Auto Setup at the bottom of the setting window.

- You may also select the Option→Auto Setup.
- The On Screen Display at right will appear during auto adjustment.
- Auto Setup may not be possible with some computer types.

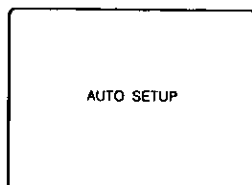

ProMouse Software Details

File Menu

- **Save**
Saves the current window status.
 - You may also click Save in the lower left corner of the setting window.
- **Exit**
Quits the ProMouse Control feature.

Option Menu

- **Clear Screen**
Deletes all the lines or stamp marks written on the screen.
- **Mouse Setting**
The dialog shown at right will appear. Sets the movement speed of the mouse using the remote control.

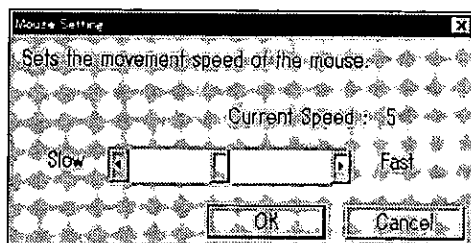

Help Menu

- **Contents**
Displays a help information of the Driver Software.
- **Version Information**
Displays a dialog indicating the version of the Driver Software.

Window Setting

- **Pointer Shape**
Selects the indicating pointer mark on the screen.
 - The currently selected pointer mark appears left end of this row.
- **Stamp**
Selects the indicator stamp mark on the screen.
 - The currently selected stamp mark appears left end of this row.
- **Remote Key Action**
You can program the \wedge , \vee , $<$, and $>$ keys as personal computer short cut keys.

[How to program]

- (1) Click on the remote key you want to be programmed in the setting window.
 - The screen shown at right will appear.
- (2) Operate the desired short cut command on the PC and click OK.
 - The key selected in step (1) will be programmed with the short cut command operated in step (2).
 - Programmed short cut keys are indicated in the setting window.
 - Because the Clear Screen command is necessary to delete lines or stamp marks from the screen, the \vee key is programmed as Clear Screen at the factory. If you wish to change this command to a different key, follow steps (1) and (2).

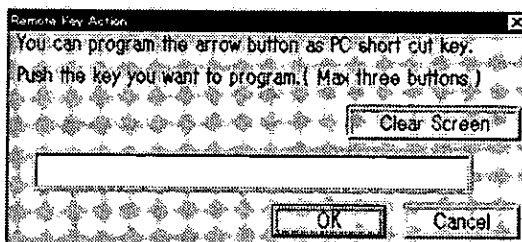

Line Style

Selects the indicating line thickness and colors on the screen.

Note:

To return all items in the setting window to their original factory setting, click on Reset.

Macintosh

System Requirements:

- System 7.1 or later
- 68030 CPU or higher, or Power Macintosh
- RAM: 2MB on-board memory
- 2MB available hard disk space
- 3.5 inch 1.44MB floppy disk drive (for installation)
- Serial port (Mini DIN 8 pin)
- Mouse

Note:

- It is possible that the above Software will not operate correctly according to the Hardware circumstances of the used PC (Personal Computer) and common use of the Application software.
- Specifications of these Software are subject to change without notice.

■ ProMouse Driver Installation

1 Turn on the Macintosh.

2 Insert the floppy disk (ProMouse driver software) into a floppy disk drive.

3 Double click the floppy disk ProMouse(E) icon.

4 Double click on the ProMouse(E) Installer icon.

5 Select the installation method, "Easy Install", "Custom Install", or "Remove".

- Easy Install
To enable ProMouse designed fat binary items to run on the Macintosh hard disk.
- Custom Install
You can select the type Macintosh.
- Remove
To remove installed ProMouse(E) software from the Macintosh hard disk.

6 Click on "Install" to start the ProMouse software installation.

7 Click on "Restart" to finish the installation and restart Macintosh.

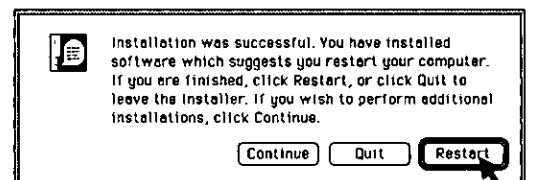
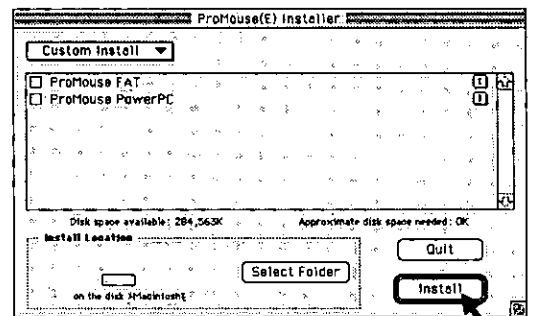
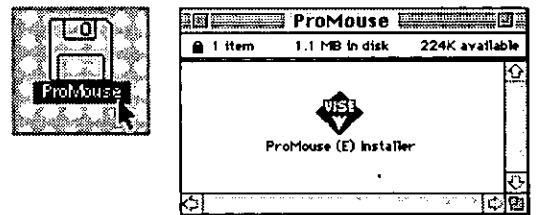

■ To Open the ProMouse Software

Double click the ProMouse icon in the ProMouse Folder.

- The ProMouse software will open.

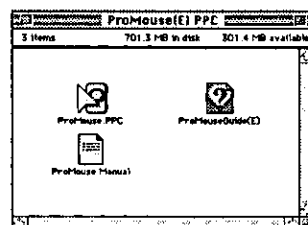

Macintosh

■ Using ProMouse Driver Software

The setting window at right will appear when ProMouse Driver Software is started up.

To start the ProMouse Control feature

Follow the steps below. Please refer to "ProMouse Software Details" (below) for detailed settings.

1 Select the Option→Connection Setting.

- The dialog shown at right will appear.

2 Select the Printer port or Modem port. Then click OK.

- Refer to the Macintosh Operation Manual for the Communication port.

3 Click on Start in the lower right corner of the setting window.

- The ProMouse Control feature will start and the setting window will be closed.

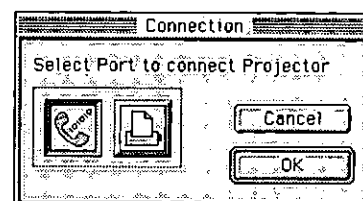
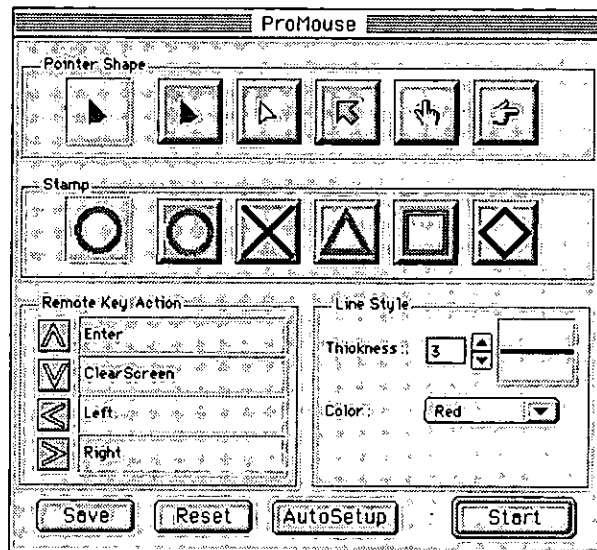

To Use the Auto Setup feature

The signal mode is identified and the Vertical position, Horizontal position, Horizontal size and Phase are automatically adjusted. Click on Auto Setup at the bottom of the setting window.

- You may also select the Option→Auto Setup.
- The On Screen Display at right will appear during auto adjustment.
- Auto Setup may not be possible with some computer types.



□ ProMouse Software Details

File Menu

● Save

Saves the current window status.

- You may also click Save in the lower left corner of the setting window.

● Quit

Quits the ProMouse Control feature.

Option Menu

● Clear Screen

Deletes all the lines or stamp marks written on the screen.

● Mouse Setting

The dialog shown at right will appear. Sets the movement speed of the mouse using the remote control.

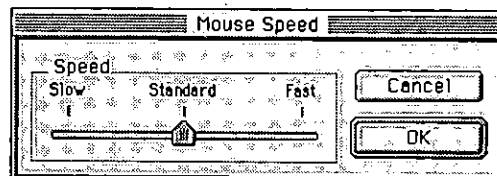

Apple Menu

● Version

Displays a dialog indicating the version of the Driver Software.

Window Setting

● Pointer Shape

Selects the indicating pointer mark on the screen.

- The currently selected pointer mark appears left end of this row.

● Stamp

Selects the indicator stamp mark on the screen.

- The currently selected stamp mark appears left end of this row.

Macintosh

Window Setting

●Remote Key Action

You can program the \wedge , \vee , $<$, and $>$ keys as personal computer short cut keys.

[How to program]

(1) Click on the remote key you want to be programmed in the setting window.

- The screen shown at right will appear.

(2) Operate the desired short cut command on the computer.

- The key selected in step (1) will be programmed with the short cut command operated in step (2).
- Programmed short cut keys are indicated in the setting window.
- Because the Clear Screen command is necessary to delete lines or stamp marks from the screen, the \vee key is programmed as Clear Screen at the factory. If you wish to change this command to a different key, follow steps (1) and (2).



●Line Style

Selects the indicating line thickness and colors on the screen.

Note:

To return all items in the setting window to their original factory setting, click on Reset.

Windows 95 / Macintosh

■ How to control the remote control

You can use the remote control in place of the computer's mouse.

Note: If the PC-Card or Video mode is selected as the input signal for the LCD Projector, the ProMouse feature cannot be used. (This includes the Pointer, Stamp, and Line functions.)

<Remote Control>

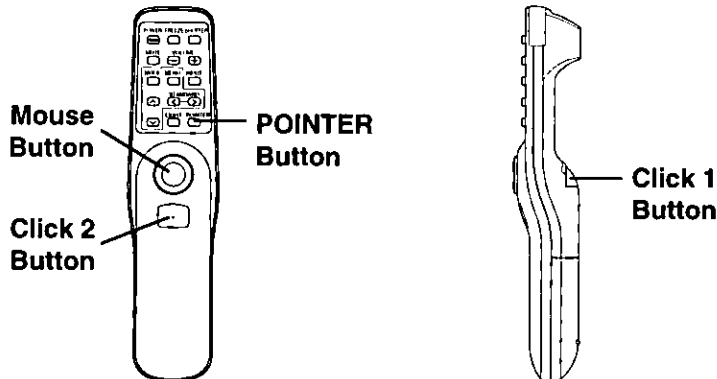

POINTER BUTTON: Each press will change the Mouse cursor mode as shown below.

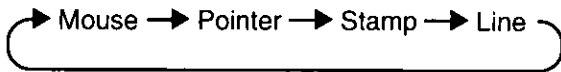

Mouse BUTTON: This can be used in place of the computer's mouse pointing device to move the screen cursor.

Click 1 BUTTON: This button corresponds to the button on a single-button mouse, or to the left button on a standard mouse with two buttons.

- When this button is pressed in Stamp mode, you can mark the screen with a stamp.
- When this button is held down and used with the Mouse button in Line mode, you can paint a line on the screen.

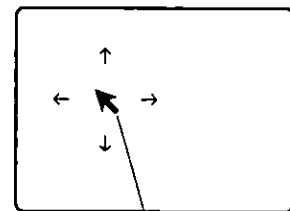

Mouse cursor

Click 2 BUTTON: This button corresponds to the right button on a standard mouse with two buttons.

- When in Mouse cursor mode (Pointer, Stamp or Line), you can return to Mouse mode by pressing this button.

Status Code Display Indications

■ Warning Indicators

This LCD Projector has a STATUS CODE Display which calls your attention to problem conditions existing inside the LCD Projector. The LCD Projector displays a Status Code Indication each time an internal problem is detected. If any of the following indications appear in the STATUS CODE Display, immediately turn off the Main Power switch, and then see the chart to determine a course of action.

<LCD Projector>

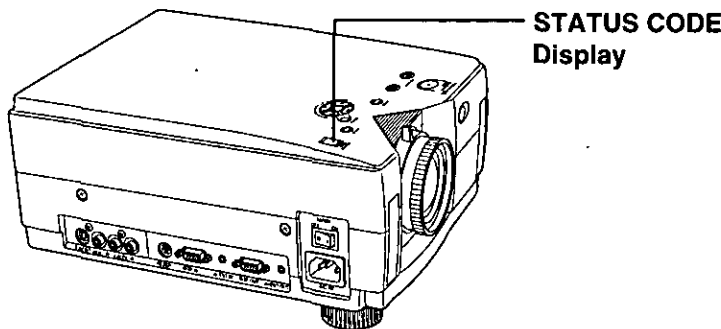

STATUS CODE	Symptom	Problem	Possible Solution
F-L	Lamp Unit automatically turns off due to abnormally high internal temperature. (Stand-by condition)	• Cooling fan malfunction.	• Take the projector to your nearest Service Center.
F-O		• Misinstalled Air Filter Unit.	• Properly install Air Filter Unit (See page 31).
A-n		• Temperature Sensor malfunction.	• Take the projector to your nearest Service Center.
A-0 A-1		• Clogged air filter. • Blocked air intake. • The surrounding temperature of the place of use may be too high.	• Clean the filter (See page 31). • Relocate projector to a proper location. • Place projector so that surrounding temperature is between 5°C (41°F) and 40°C (104°F) and the humidity is between 10% and 80% (with no condensation).
L-n	Lamp does not light up.	• Lamp is burned-out.	• Take the projector to your nearest Service Center.
P-2		• Lamp Voltage is not correct.	
P-3	Abnormally high internal temperature.	• Abnormal temperature rise.	
P-4		• Others cause.	
L-1	Lamp operation time is over 1000 hours.	• It is nearly time to replace the Lamp Unit.	• Replace the Lamp unit. (See pages 32, 33).
L-0	Lamp operation time is over 1100 hours.	• The Lamp Unit must be replaced.	
C-d	Forced cooling fan operating to expedite lamp replacement (See page 33).	—	—

Note:

- Please wait one minute before turning the power back on, to allow the lamp to cool. A much longer time may be required if the projector had attained an abnormally high internal temperature.

Cleaning the Air Filter

■ Air Filter

The air filter should be cleaned about every 100 hours. Also, clean the air filter if the "A-0" is indicated in the STATUS CODE display.

Replace the filter when it is clogged or dirty even after cleaning.

■ Cleaning procedure

Tools required: Vacuum Cleaner.

- Wait until the cooling fan stops and the STANDBY(R) ON(G) indicator turns solid red.

1 Set the Main Power Switch to OFF and unplug the power cord.

2 Place the LCD Projector up on its side as illustrated.

3 Remove the Air Filter unit

Hold the indent on the Air Filter unit with your hands and pull the Air Filter unit out of the LCD Projector.

4 Clean the Filter.

Gently remove any accumulated dust from Air Filter unit with your vacuum cleaner.

CAUTION: Operating LCD Projector with torn or damaged Filter may cause damage to LCD Projector.

5 Replace the Air Filter unit.

Slide the Air Filter unit into the LCD Projector until hollows in the Air Filter unit are aligned with the hollows in the Projector.

Note:

- The LCD Projector power cannot be turned on unless the Air Filter unit is correctly installed.

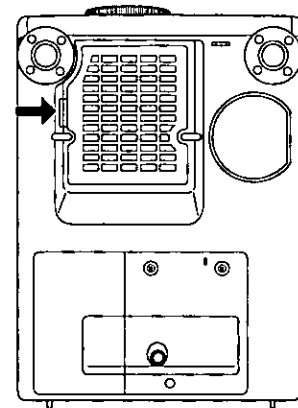
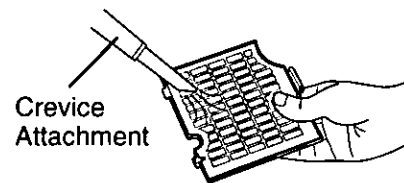
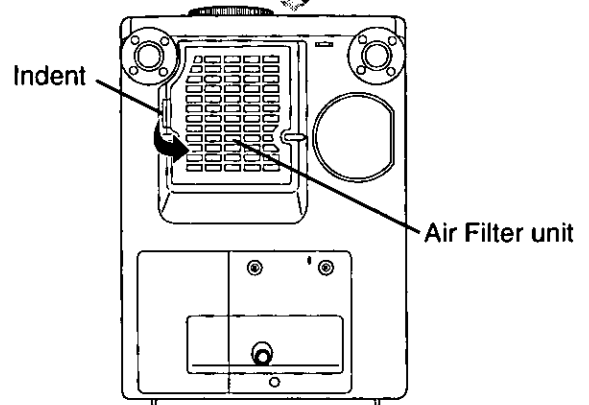
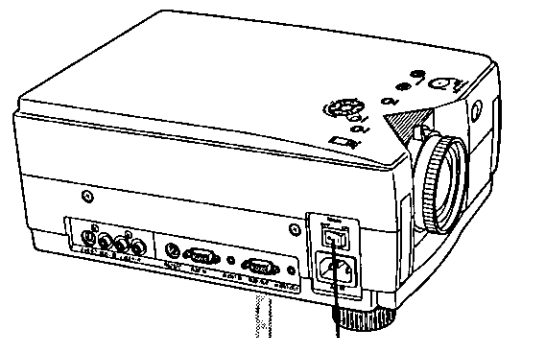

Lamp Replacement

■ Lamp replacement period

The LCD Projector lamp has a limited operating life of approximately 1100 hours.

“LAMP TIME REMAINING 10h” will be displayed on-screen when operation time reaches 1090 hours.

Then, each time the power is turned on, the Lamp life remaining will be displayed.

- A 10 second warning display (15 seconds when the LCD Projector power is turned on) will appear every 1 hour from 1090 hours of operation time. And the warning will flash during the last 5 minutes of Lamp life.

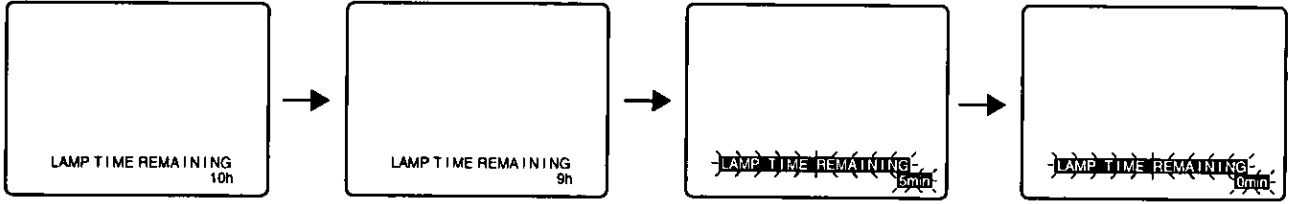

In Case Lamp Use Reaches 1100 hours

The LCD Projector will shut itself OFF and the STATUS CODE indication becomes “L-0”.
(See STATUS CODE on page 30.)

- Replace the Lamp as described in steps 1-7 and step 8 on page 33.
- Press POWER ON, the LAMP TIME RESET display will appear to reset the Lamp time.
 - Only this screen will be displayed when POWER is pressed until lamp time is reset.
(The LCD Projector cannot display a normal picture.)
 - If the Lamp Time is not reset, this screen will disappear and the LCD Projector will shut itself OFF after about 10 minutes.
- Press < or > to select YES.
- Turn the POWER OFF to reset the Lamp Time.

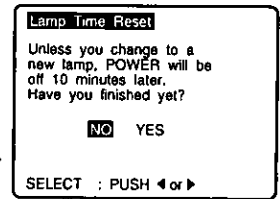

■ Lamp replacement procedure

Order Lamp ET-LA555.
Tools required: A coin.

- 1 After the cooling fan has stopped, and **STANDBY(R) ON(G)** indicator turns solid red. Set the Main Power Switch to **OFF** and unplug the power cord.

Note: Please wait more than one hour for lamp replacement.

[If you need to replace the lamp more urgently]

- The LCD Projector has a forced cooling feature. After the POWER switch is turned OFF, and sometime during about the first minute of the normal cooling fan operation, press < and > at same time. The cooling fan will change to high speed for about 10 minutes. (The "C-d" STATUS CODE will be displayed.)

- 2 Grabbing the handle, place the LCD Projector up on its side as illustrated.

- 3 Remove the Lamp cover screws.

First read caution and warning labels on Lamp cover. Then, remove the Lamp cover screws (2) by using coin, and take off the lamp cover.

- 4 Remove the Lamp unit screw.

Remove the lamp unit screw (2), then grasp the Lamp unit handle and carefully pull it from the LCD Projector. Keep Lamp housing opening to your right. Do not touch Lamp or point Lamp opening at anyone.

WARNING: The lamp may be hot. Be careful when handling.

CAUTION: High-pressure lamp may explode if improperly handled.

- 5 Install the new Lamp unit.

Remove the Lamp ET-LA555 from the LCD Projector and install a new lamp unit (ET-LA555).

- Do not drop, impact of dropping may cause Lamp to explode.

- 6 Replace the Lamp unit screws.

Replace the Lamp unit screw and the Lamp cover screws using a coin to tighten.

- Properly dispose of old Lamp.

- 7 Plug the LCD Projector back in by inserting Power cord in LCD Projector AC socket and set the Main Power Switch to **ON**.

- 8 Press **POWER** to turn LCD Projector ON.

- 9 Press **MENU** to display the menu.

- 10 Press **▲** or **▼** to select **SET UP PROJECTOR**, and then press **<** or **>** to display the screen.

- 11 Press **▲** or **▼** to select **LAMP TIME RESET**, and then press **<** or **>** to display the screen.

- 12 Press **<** to select **YES**. "Push POWER button to reset" will appear.

- 13 Press **POWER** to reset the Lamp Time to "0".

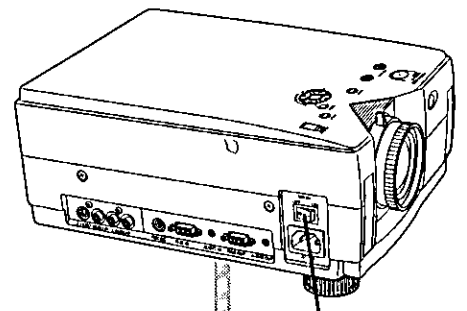

Main Power Switch

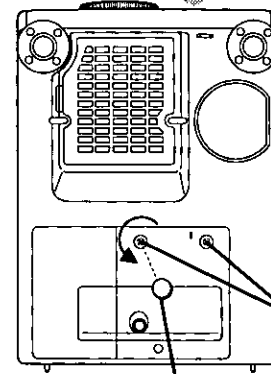

Lamp cover screw

Coin

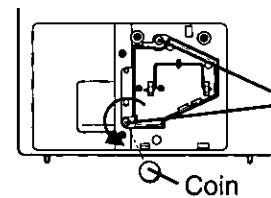

Lamp unit screw

Coin

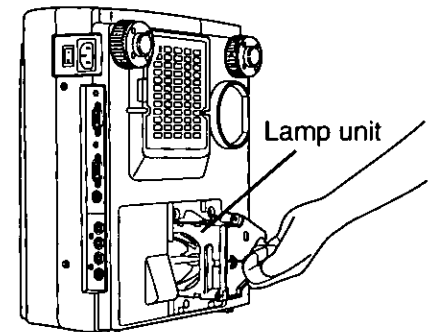

Lamp unit

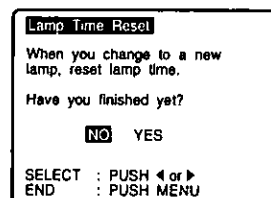
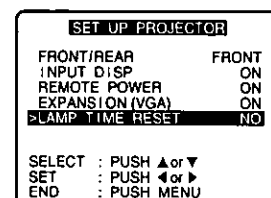
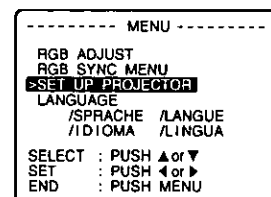

Before Requesting Service

If the LCD Projector unit fails, check the following before calling your dealer for service.

Problem	Possible Cause
Power does not turn on.	<ul style="list-style-type: none"> • The power cord may not be connected. • The main power switch on the projector may be turned off. • The main power supply may not be supplied to the wall outlet. • The Status Codes are indicated on the STATUS CODE Display. (p. 30) • The lamp unit or lamp unit cover may not have been correctly installed. (p. 33) • The Air Filter Unit may not have been correctly installed. (p. 31)
No picture appears.	<ul style="list-style-type: none"> • The lens cap may still be attached to the lens. • The signal input source may not be connected properly. (pp. 12 - 13) • The input selection setting may not be correct. (p.19) • The BRIGHTNESS adjustment may be lowest setting. (p.22) • The LCD Projector may be set SHUTTER mode. (p.19)
The picture is fuzzy.	<ul style="list-style-type: none"> • The lens focus may not have been set correctly, or the projector may not be at the correct distance from the screen. (pp.10 - 11) • The lens may be dirty. • The LCD projector may not be set up so that it is perpendicular to the screen. (pp.10 - 11) • The VIDEO or R, G, B adjustments may not have been set correctly. (pp. 22 - 24)
"FOCUS" or "NO SYNC" appears on screen.	<ul style="list-style-type: none"> • The signal input source may not be connected properly. (pp. 12 - 13) • The input selection setting may not be correct. (p.19) • The connected signal source may be turned off. (p. 21)
Color is too light or tint is poor.	<ul style="list-style-type: none"> • COLOR or TINT adjustment may be incorrect. (p. 22) • The video formats may not match. (p. 20) • The signal connection pin assignments may not be correct. (pp. 14 - 15)
No sound can be heard.	<ul style="list-style-type: none"> • The audio signal source may not be connected properly. (pp. 12 - 13) • The volume adjustment may be at the lowest possible setting. (p. 19) • The MUTE function or Audio/Video SHUTTER function may be active. (p. 19)
Remote Control does not operate.	<ul style="list-style-type: none"> • The batteries may be spent, or they may not be inserted correctly. (p. 7) • There may be an object blocking the infrared signals between remote control unit and the projector. • The remote control unit may be out of the operating range. (p. 7)

Specifications

LCD panels		0.9" Poly silicon LCD panel X 3, RGB shutter method, using Translucent TN crystal panels
Drive method		Active Matrix 4:3 Aspect Ratio panels, TFT (Thin Film Transistor)
No. of pixels		480,000 (800 X 600) stripe pixels X 3 panels
Lens		1 -1.5 zoom lens , F2.5 - 2.7, f32 - 48mm Manual Focus
Projector lamp		Metal halide 150 W
Contrast ratio		200 : 1
Brightness		450 lumen / ANSI
Unlimited number of colors		16,777,216
Screen size		20" - 300" (measured diagonally)
Projection (throw) distance		3.18' - 51.84'
Keystone Correction		1 : 9 Low position
Video input signal		PAL/SECAM/NTSC/PAL-M/PAL-N/NTSC4.43 Composite video, 1 Vp-p, sync negative, 75Ω terminated
S-Video input signal		Y (luminance signal) : 1 Vp-p, sync negative, 75Ω terminated C (chrominance signal) : burst 0.286 Vp-p, 75Ω terminated
RGB input signal	Video signal	RGB Analog (0.7 Vp-p, 1.0 Vp-p with sync on green, 75Ω) Unlimited number of colors
	Sync signal	H/V separate, H/V composite, or Sync-on-Green
	H-Frequency	24.83 - 60.24 KHz (TTL Level) ← Refer to pages 16 - 18.
	V-Frequency	56.25 - 85.1 Hz (TTL Level) ← Refer to pages 16 - 18.
Connectors		S-Video Input: Mini DIN 4-pin X 1 PAL/SECAM/NTSC/PAL-M/PAL-N/NTSC4.43 Video Input : RCA pin X 1 Video Audio Input: RCA PIN X 2 (L + R) Serial Port (RS-232C): Mini DIN 8-pin X 1 RGB Display Input: D-Sub mini 15-pin X 1 RGB Audio Input: M3 stereo mini pin X 1 RGB Display Output: D-Sub mini 15-pin X 1 Audio output: M3 stereo mini pin X 1
Controls	Cabinet Buttons/ Switches	Main Power ON/OFF, Power ON/OFF, Volume +/-, Mode, Menu, Input, Λ, V, < , >
	Remote Control Buttons	Power ON/OFF, Freeze, Shutter, Mute, Volume +/-, Mode, Menu, Input, Λ, V, < , >, Light, Pointer, Mouse, Click1, Click2
Audio output		1.5 W (10% THD)
Speaker		2.76" X 1.58" X 1 (70 mm X 40 mm X 1)
Operating Temperature		41°F to 104 °F (5°C to 40°C)
Operating Humidity		10% - 80% (non-condensation)
Storage Temperature		-13°F to 104°F (-25°C to 40°C) 104°F to 140°F (40°C to 60°C)
Storage Humidity		5% - 85% (non-condensing) Normal humidity
Power Supply		100 - 240 V AC (50 or 60 Hz) Automatic
Power Consumption		250 W
Dimensions W x H x D		9 - 7/16" X 5-15/16" X 12 - 13/16" (240 X 151 X 325 mm)
Amps		2.5 A - 1.1 A
Weight		12.5 lbs. (5.7 kg)
Approvals		FCC, UL, C-UL

Note:

•Specifications and design subject to change without notice.

Notes importantes concernant la sécurité



ATTENTION: Lire toutes ces instructions avant d'utiliser votre projecteur. Conserver le mode d'emploi en lieu sûr afin de pouvoir le consulter ultérieurement.

L'énergie électrique peut effectuer plusieurs fonctions utiles. Ce projecteur à affichage à cristaux liquides a été conçu et fabriqué pour répondre aux normes de sécurité en vigueur. Mais une **UTILISATION INCORRECTE PEUT PROVOQUER UNE DECHARGE ELECTRIQUE OU UN INCENDIE**. Afin de ne pas supprimer les protections incorporées dans ce projecteur à affichage à cristaux liquides, respectez les règles de base suivantes pour son installation, utilisation et réparation.

- 1 Débrancher le projecteur de la prise de courant murale avant d'entreprendre le nettoyage.
- 2 Ne pas appliquer des produits de nettoyage liquides ou des aérosols. Utiliser un chiffon doux et sec pour nettoyer le projecteur. Si le projecteur est très sale, tremper un chiffon dans un détergent neutre, bien essorer le chiffon, puis essuyer le boîtier et terminer en essuyant avec un chiffon doux. Ne pas utiliser un dépolissant chimique ou un nettoyant lustrant parce qu'il risque de détériorer le boîtier et de décaper le revêtement de peinture.
- 3 Ne pas utiliser des accessoires non recommandés par Panasonic, car ils risquent de provoquer des dangers.
- 4 Ne pas utiliser le projecteur près de l'eau; par exemple, près d'une baignoire, un lavabo, un évier, une cuve à lessive, dans un sous-sol mouillé, près d'une piscine, etc. Ne jamais renverser de liquides dans le projecteur.
- 5 Ne pas placer le projecteur sur un chariot, un support ou une table instable. Le projecteur risque de tomber, ce qui pourrait provoquer des blessures graves à un enfant ou un adulte, et/ou endommager l'appareil. Utiliser uniquement avec un chariot ou un support recommandé par le fabricant et adapté à l'utilisation d'un projecteur à affichage à cristaux liquides.
- 6 Le montage au plafond, contre un mur ou sur une étagère doit se faire à l'aide d'un kit de montage agréé par le fabricant.
- 7 Le projecteur à affichage à cristaux liquides et le chariot doivent être déplacés avec soin. Des arrêts brusques, une force excessive et des surfaces inégales risquent de faire basculer l'équipement et le chariot.
- 8 Les fentes et orifices au dos et au fond du boîtier sont destinés à la ventilation. Afin de garantir un fonctionnement fiable du projecteur à affichage à cristaux liquides et de le protéger contre le surchauffement, ces orifices ne doivent pas être bloqués ou couverts. Ces orifices ne doivent jamais être couverts par un tissu ou un autre matériau. L'orifice du fond ne doit pas être bloqué en plaçant le projecteur à affichage à cristaux liquides sur un lit, un fauteuil, un tapis ou toute autre surface similaire. Le projecteur à affichage à cristaux liquides ne doit pas être placé près d'un radiateur ou sur le dessus ou près d'une cheminée. Le projecteur à affichage à cristaux liquides ne doit pas être encastré sauf si une ventilation correcte est assurée.
- 9 Le projecteur doit être utilisé uniquement avec le type de source d'alimentation indiquée au dos du projecteur ou dans les caractéristiques techniques.
En cas de doute sur le type d'alimentation électrique de votre entreprise, consulter le revendeur de votre projecteur à affichage à cristaux liquides ou la compagnie d'électricité locale.
- 10 Ne rien poser sur le cordon d'alimentation. Ne pas placer le projecteur à affichage à cristaux liquides dans un endroit où le cordon sera sur un lieu de passage.
- 11 Respecter les avertissements et instructions marqués sur le projecteur à affichage à cristaux liquides.
- 12 Par mesure de sécurité, ce projecteur est équipé. S'il n'est pas possible d'insérer la fiche dans la prise, utiliser un adaptateur confier l'installation d'une prise de terre à un électricien. Ne pas essayer de modifier cette fiche secteur.
- 13 Pour améliorer la protection du projecteur à affichage à cristaux liquides pendant un orage ou lorsqu'il est laissé sans surveillance ou inutilisé pendant une longue période, débranchez la fiche de la prise murale et débranchez tous les câbles. Cela évite d'endommager le projecteur par la foudre et les surtensions des lignes d'alimentation.



- 14** Ne pas surcharger les prises murales et les cordons de rallonge avec trop d'appareils car cela risque de provoquer un incendie ou une décharge électrique.
- 15** Ne jamais enfoncer d'objets de quelque sorte dans le projecteur à affichage à cristaux liquides par les fentes du boîtier, car ils pourraient toucher des points dangereux sous haute tension ou générer des court-circuits, qui risquent de provoquer un incendie ou une décharge électrique.
- 16** Ne pas essayer de réparer le projecteur à affichage à cristaux liquides soi-même. L'ouverture ou l'arrachement des couvercles risque de vous exposer à une tension dangereuse ou à d'autres dangers. Confiez tous travaux de dépannage à un dépanneur qualifié.
- 17** Débrancher le projecteur à affichage à cristaux liquides de la prise murale et confiez le dépannage à un dépanneur qualifié dans les conditions suivantes:
 - A. Lorsque le cordon d'alimentation ou la fiche est endommagée ou effilochée.
 - B. Si du liquide a été renversé dans le projecteur à affichage à cristaux liquides.
 - C. Si le projecteur à affichage à cristaux liquides a été exposé à la pluie ou à l'humidité.
 - D. Si le projecteur à affichage à cristaux liquides ne fonctionne pas normalement lorsque les instructions d'utilisation ont été suivies. Réglez uniquement les commandes décrites dans les instructions d'utilisation; un réglage incorrect des autres commandes risque de provoquer des dégâts et nécessiteront souvent un travail approfondi par un technicien qualifié pour remettre le projecteur à affichage à cristaux liquides en état de fonctionnement normal.
 - E. Si le projecteur à affichage à cristaux liquides a subi une chute ou si le boîtier a été endommagé.
 - F. Lorsque le projecteur à affichage à cristaux liquides présente un changement distinct dans sa performance - cela signifie une nécessité de réparation.
- 18** A la fin de tout entretien ou réparation du projecteur à affichage à cristaux liquides, demandez au technicien du service après-vente d'effectuer une vérification de sécurité de routine afin de déterminer si le projecteur à affichage à cristaux liquides est en état de fonctionnement.
- 19** Lorsque le remplacement des pièces est nécessaire, s'assurer que le technicien du service après-vente a utilisé les pièces de remplacement spécifiées par le fabricant et ayant les mêmes caractéristiques que les pièces d'origine. Des substitutions non autorisées risquent de provoquer un incendie, une décharge électrique ou d'autres dangers.
- 20** Le filtre à air doit être nettoyé toutes les 100 heures de fonctionnement de la lampe.
Le projecteur à affichage à cristaux liquides risque de devenir trop chaud si le filtre n'est pas nettoyé lorsque cela est nécessaire.
- 21** Si l'objectif est sale ou encrassé, le nettoyer avec un chiffon propre, mouillé. Ne jamais toucher l'objectif avec les doigts.
- 22** Ne pas regarder à travers l'ouverture et l'objectif pendant que le projecteur fonctionne, car cela risque de provoquer des lésions oculaires.

Remplacement de la lampe

■ Période de remplacement de la lampe

La lampe du projecteur LCD a une durée de service limitée de 1100 heures environ.

“LAMP TIME REMAINING 10h” (temps restant de la lampe) est affiché à l'écran, lorsque la durée de service atteint 1090 heures.

Ensuite, chaque fois que le projecteur est allumé, la durée de vie restante de la lampe sera affichée.

- Un affichage d'avertissement de 10 secondes (15 secondes lorsque le projecteur LCD est allumé) apparaît toutes les heures à partir de la durée de service de 1090 heures. Et l'avertissement clignote pendant les dernières 5 minutes de la durée de vie de la lampe.

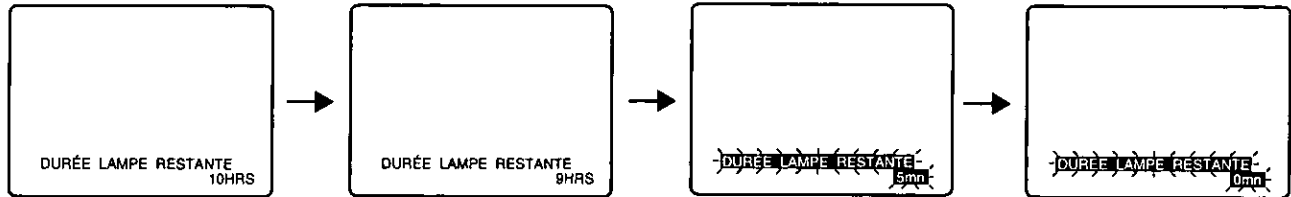

Lorsque la lampe atteint 1100 heures d'utilisation

Le projecteur LCD s'éteint automatiquement et l'indicateur STATUS CODE (code de statut) affiche “L-0”.

- Remplacer la lampe comme décrit dans les étapes 1-7 et l'étape 8 ci-dessous.
- Appuyer sur la touche POWER ON (mise sous tension), l'affichage LAMP TIME RESET (remise à zéro de la durée de service de la lampe) apparaît pour la remise à zéro de la durée de service de la lampe.
 - Seul cet écran sera affiché lorsque la touche POWER (marche) est enfoncée jusqu'à la remise à zéro de la durée de la lampe. (Le projecteur LCD ne peut pas afficher une image normale.)
 - Si la durée de la lampe n'est pas remise à zéro, cet écran apparaîtra et le projecteur LCD s'éteint automatiquement après 10 minutes environ.
- Appuyer sur la touche < ou > pour sélectionner YES (oui).
- Appuyer sur la touche POWER OFF (arrêt) pour remettre la durée de service de la lampe à zéro.

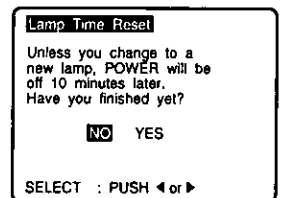

■ Procédure de remplacement de la lampe

Commander la lampe ET-LA555.

Outil nécessaire: une pièce de monnaie.

- 1 Lorsque le ventilateur de refroidissement s'est arrêté, et l'indicateur **STANDBY(R) ON(G)** (attente(R)/mise sous tension) devient rouge, régler l'interrupteur principal sur **OFF** et débrancher le cordon d'alimentation.

Remarque: Attendre au moins une heure avant de remplacer la lampe.

[Pour un remplacement prématuré de la lampe]

- Le projecteur LCD possède une fonction de refroidissement forcé. Lorsque le commutateur de tension **POWER** est mis sur **OFF** (hors tension), et pendant environ la première minute du fonctionnement normal du ventilateur de refroidissement, appuyer sur **<** et **>** en même temps. Le ventilateur de refroidissement passe alors en vitesse rapide pendant 10 minutes. (Le **STATUS CODE** "C-d" est alors affiché.)

- 2 Tout en saisissant la poignée, placer le projecteur LCD debout sur son côté comme illustré.

- 3 Retirer les vis du couvercle de la lampe.

Lire d'abord les plaques de mise en garde et d'avertissement sur le couvercle de la lampe. Ensuite, retirer les (2) vis du couvercle de la lampe avec une pièce de monnaie, et sortir le couvercle de la lampe.

AVERTISSEMENT: La lampe risque d'être chaude. Faire attention lors de sa manipulation.

ATTENTION: La lampe haute pression risque d'exploser si elle est utilisée incorrectement.

- 4 Retirer la vis de l'unité de la lampe.

Retirer la vis (2) de l'unité de la lampe, puis saisir la poignée de la lampe et la sortir délicatement du projecteur LCD. Tenir l'ouverture du boîtier de la lampe à droite. Ne pas toucher la lampe et ne pas pointer l'ouverture de la lampe sur quelqu'un.

- 5 Installer l'unité de la lampe neuve.

Retirer la lampe ET-LA555 du projecteur LCD et installer une unité de lampe neuve (ET-LA555).

- Ne pas faire tomber la lampe, car le choc après une chute risque de faire exploser la lampe.

- 6 Remettre les vis de l'unité de la lampe en place.

Remettre la vis de l'unité de la lampe et les vis du couvercle de la lampe en place à l'aide d'une pièce de monnaie pour les visser.

- Eliminer la lampe usagée selon les prescriptions en vigueur.

- 7 Rebrancher le projecteur LCD en insérant le cordon d'alimentation dans la prise CA du projecteur LCD et mettre l'interrupteur principal sur la position **ON** (marche).

- 8 Appuyer sur la touche **POWER** (marche) pour allumer le projecteur LCD.

- 9 Appuyer sur la touche **MENU** pour afficher le menu.

- 10 Appuyer sur la touche **▲** ou **▼** pour sélectionner **SET UP PROJECTOR** (initialisation du projecteur), et appuyer ensuite sur la touche **<** ou **>** pour afficher l'écran.

- 11 Appuyer sur la touche **▲** ou **▼** pour sélectionner **LAMP TIME RESET** (remise à zéro de la durée de service de la lampe), et appuyer ensuite sur la touche **<** ou **>** pour afficher l'écran.

- 12 Appuyer sur la touche **<** ou **>** pour sélectionner **YES**. "Push POWER button to reset" (oui remettre la durée de service à zéro à l'aide de la touche d'alimentation) apparaît à l'écran.

- 13 Appuyer sur la touche **POWER** (marche) pour remettre la durée de service de la lampe à "0".

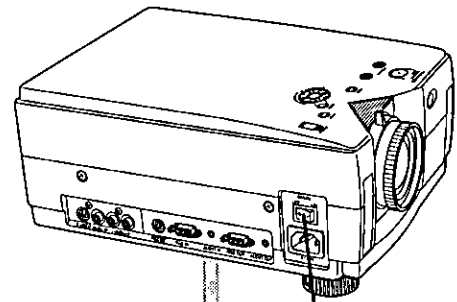

Interrupteur d'alimentation principale

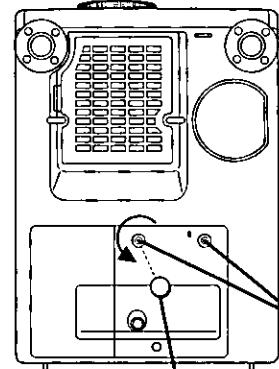

Vis du couvercle de la lampe

Pièce de monnaie

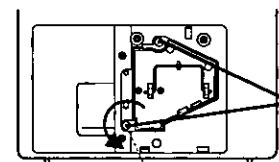

Vis de l'unité de la lampe

Pièce de monnaie

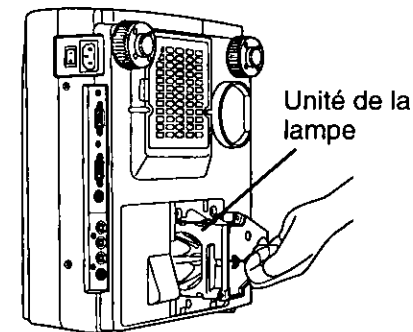

Unité de la lampe

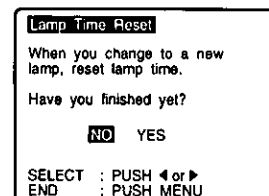
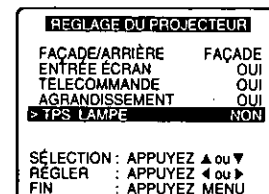
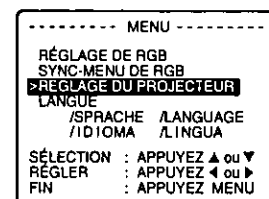

Panasonic®

Professional/Industrial Video

Panasonic Broadcast & Television Systems Company

Division of Matsushita Electric Corporation of America

Executive Office:

One Panasonic Way (3F-5), Secaucus, New Jersey 07094

EASTERN ZONE: (610) 269-8369

CENTRAL ZONE: (608) 846-4778

WESTERN ZONE: (707) 584-7189

Government Marketing Department: 52 West Gude Drive, Rockville, MD 20850 (301) 738-3840

Panasonic Canada Inc.

5770 Ambler Drive, Mississauga, Ontario L4W 2T3 (905) 624-5010

Printed in Japan
LSQT0128 (A)